

VAMP 265

Transformer, generator and
motor differential protection relay

Publication version: V265/en M/G014

User Manual



Trace back information:
Workspace Main version a136
Checked in 2017-03-16
Skribenta version 4.6.323

Table of Contents

1	General	7
1.1	Legal notice	7
1.2	Safety information	7
1.3	Relay features	9
1.3.1	User interface	9
1.4	Related documents	10
1.5	Periodical testing	10
1.6	EU directive compliance	10
1.7	Abbreviations	11
2	Local panel user interface	13
2.1	Relay front panel	13
2.1.1	Display	15
2.1.2	Adjusting display contrast	16
2.2	Local panel operations	17
2.2.1	Menu structure of protection functions	20
2.2.2	Setting groups	22
2.2.3	Fault logs	24
2.2.4	Operating levels	25
2.3	Operating measures	27
2.3.1	Control functions	27
2.3.2	Measured data	28
2.3.3	Reading event register	29
2.3.4	Forced control (Force)	30
2.4	Configuration and parameter setting	31
2.4.1	Parameter setting	32
2.4.2	Setting range limits	33
2.4.3	Disturbance recorder menu DR	33
2.4.4	Configuring digital inputs DI	34
2.4.5	Configuring digital outputs DO	35
2.4.6	Protection menu Prot	35
2.4.7	Configuration menu CONF	35
2.4.8	Protocol menu Bus	38
2.4.9	Single line diagram editing	42
2.4.10	Blocking and Interlocking configuration	43
3	VAMPSET PC software	44
3.1	Folder view	44
4	Introduction	46
4.1	Main features	46
4.2	Principles of numerical protection techniques	47

5	Protection functions	49
5.1	Maximum number of protection stages in one application	49
5.2	General features of protection stages	49
5.3	Differential overcurrent protection $\Delta I >$ (87)	54
5.4	Overcurrent protection $I >$ (50/51)	59
5.4.1	Remote controlled overcurrent scaling	63
5.5	Current unbalance protection $I_{2>}, I'_{2>}$ (46)	64
5.6	Earth fault protection $I_{0>}$ (50N/51N)	66
5.6.1	Earth fault faulty phase detection algorithm	71
5.7	Thermal overload protection $T >$ (49)	74
5.8	Magnetising inrush $I_{f2} >$ (68F2)	77
5.9	Transformer over excitation $I_{f5} >$ (68F5)	79
5.10	Circuit breaker failure protection CBFP (50BF)	80
5.11	Programmable stages (99)	81
5.12	Arc fault protection (50ARC/50NARC) optional	84
5.13	Inverse time operation	88
5.13.1	Standard inverse delays IEC, IEEE, IEEE2, RI ...	90
5.13.2	Free parameterization using IEC, IEEE and IEEE2 equations	100
5.13.3	Programmable inverse time curves	101
6	Supporting functions	103
6.1	Event log	103
6.2	Disturbance recorder	105
6.2.1	Running virtual comtrade files	109
6.3	Current transformer supervision	110
6.4	Circuit breaker condition monitoring	110
6.5	System clock and synchronization	116
6.6	Running hour counter	122
6.7	Timers	123
6.8	Combined overcurrent status	125
6.9	Self-supervision	127
6.9.1	Diagnostics	127
7	Measurement functions	129
7.1	Measurement accuracy	130
7.2	RMS values	130
7.3	Harmonics and Total Harmonic Distortion (THD)	131
7.4	Demand values	132
7.5	Minimum and maximum values	132
7.6	Maximum values of the last 31 days and 12 months	133
7.7	Primary secondary and per unit scaling	133
7.7.1	Current scaling	134
8	Control functions	137
8.1	Output relays	137
8.2	Digital inputs	138

8.3	Virtual inputs and outputs	140
8.4	Output matrix	141
8.5	Blocking matrix	142
8.6	Controllable objects	142
8.6.1	Controlling with DI	144
8.6.2	Local/Remote selection	144
8.7	Logic functions	144
9	Communication	147
9.1	Communication ports	147
9.1.1	Local port X4	148
9.1.2	Remote port X5	150
9.1.3	Extension port X4	151
9.1.4	Ethernet port	152
9.2	Communication protocols	154
9.2.1	PC communication	154
9.2.2	Modbus TCP and Modbus RTU	155
9.2.3	Profibus DP	156
9.2.4	SPA-bus	158
9.2.5	IEC 60870-5-103	159
9.2.6	DNP 3.0	161
9.2.7	IEC 60870-5-101	162
9.2.8	External I/O (Modbus RTU master)	163
9.2.9	IEC 61850	163
9.2.10	EtherNet/IP	164
9.2.11	FTP server	164
9.2.12	DeviceNet	165
10	Applications	166
10.1	Restricted earth fault protection	166
10.2	Restricted earth fault protection for a transformer with neutral connection	167
10.2.1	CT Requirements	168
10.3	Calculating the stabilizing resistance R_S , VDR value and actual sensitivity	169
10.3.1	Value of stabilizing resistor R_S	169
10.3.2	Voltage limit	170
10.3.3	Actual operating sensitivity	171
10.3.4	Example	171
10.4	Current Transformer Selection	172
10.4.1	CT classification according IEC 60044-1, 1996	172
10.4.2	CT Requirement for Protection	175
10.4.3	Example	176
10.5	Protection of a Dyn11 transformer	178
10.6	Protection of a YNd11 transformer	180
10.7	Protection of generator and block transformer	181
10.8	Application example of differential protection using VAMP 265	182

10.9	Trip circuit supervision	183
10.9.1	Trip circuit supervision with one digital input	183
10.9.2	Trip circuit supervision with DI19 and DI20	192
11	Connections	196
11.1	Rear panel	196
11.2	Auxiliary voltage	200
11.3	Serial communication connection	200
11.3.1	Front panel connector	200
11.3.2	Rear panel connector X5 (REMOTE)	201
11.3.3	X4 rear panel connector (local RS232 and extension RS485 ports)	206
11.4	Optional two channel arc protection card	206
11.5	Optional digital I/O card (DI19/DI20)	207
11.6	External option modules	208
11.6.1	External LED module VAM 16D	208
11.6.2	Third-party external input / output modules	208
11.7	Block optional diagram	214
11.8	Block diagrams of option modules	215
11.8.1	Block diagrams of optional modules	215
11.8.2	Block diagram of optional DI19/DI20	215
11.9	Connection examples	216
12	Technical data	217
12.1	Connections	217
12.2	Test and environmental conditions	221
12.3	Protection functions	223
12.3.1	Differential protection	223
12.3.2	Non-directional current protection	224
12.3.3	Circuit-breaker failure protection CBFP (50BF)	227
12.3.4	Magnetising inrush 68F2	227
12.3.5	Over excitation 68F5	227
12.3.6	Arc fault protection (option)	228
12.4	Supporting functions	229
13	Mounting	230
14	Order information	232
15	Revision history	234

1 General

1.1 Legal notice

Copyright

2017 Schneider Electric. All rights reserved.

Disclaimer

No responsibility is assumed by Schneider Electric for any consequences arising out of the use of this document. This document is not intended as an instruction manual for untrained persons. This document gives instructions on device installation, commissioning and operation. However, the manual cannot cover all conceivable circumstances or include detailed information on all topics. In the event of questions or specific problems, do not take any action without proper authorization. Contact Schneider Electric and request the necessary information.

Contact information

35 rue Joseph Monier

92506 Rueil-Malmaison

FRANCE

Phone: +33 (0) 1 41 29 70 00

Fax: +33 (0) 1 41 29 71 00

www.schneider-electric.com

1.2 Safety information

Important Information

Read these instructions carefully and look at the equipment to become familiar with the device before trying to install, operate, service or maintain it. The following special messages may appear throughout this bulletin or on the equipment to warn of potential hazards or to call attention to information that clarifies or simplifies a procedure.



The addition of either symbol to a “Danger” or “Warning” safety label indicates that an electrical hazard exists which will result in personal injury if the instructions are not followed.



This is the safety alert symbol. It is used to alert you to potential personal injury hazards. Obey all safety messages that follow this symbol to avoid possible injury or death.

⚠ DANGER

DANGER indicates an imminently hazardous situation which, if not avoided, **will result in** death or serious injury.

⚠ WARNING

WARNING indicates a potentially hazardous situation which, if not avoided, **can result in** death or serious injury.

⚠ CAUTION

CAUTION indicates a potentially hazardous situation which, if not avoided, **can result in** minor or moderate injury.

NOTICE

NOTICE is used to address practices not related to physical injury.

User qualification

Electrical equipment should be installed, operated, serviced, and maintained only by trained and qualified personnel. No responsibility is assumed by Schneider Electric for any consequences arising out of the use of this material. A qualified person is one who has skills and knowledge related to the construction, installation, and operation of electrical equipment and has received safety training to recognize and avoid the hazards involved.

Password protection

Use IED's password protection feature in order to protect untrained person interacting this device.

⚠ WARNING**WORKING ON ENERGIZED EQUIPMENT**

Do not choose lower Personal Protection Equipment while working on energized equipment.

Failure to follow these instructions can result in death or serious injury.

1.3 Relay features

VAMP 265 differential protection relay is ideal for transformer, motor, generator and short cable (100) differential protection. The relay features the following protection functions.

Table 1.1: List of protection functions

IEEE/ANSI code	IEC symbol	Function name
46	$I_2>, I'_2>$	Current unbalance protection
49	T>	Thermal overload protection
50/51	$3I>, 3I>>, 3I'>, 3I'>>$	Overcurrent protection
50ARC/ 50NARC	$Arcl>, Arcl'>, Arcl_{01}>, Arcl_{02}>$	Optional arc fault protection
50BF	CBFP	Circuit-breaker failure protection
50N/51N	$I_0>, I_0>>, I_0>>>, I_0>>>>$	Earth fault protection
68F2	$I_{f2}>$	Magnetising inrush
68F5	$I_{f5}>$	Transformer overexcitation
87	$\Delta I>, \Delta I>>$	Differential overcurrent protection
99	Prg1 – 8	Programmable stages

Further the relay includes a disturbance recorder. Arc protection is optionally available.

The relay communicates with other systems using common protocols, such as the Modbus RTU, ModbusTCP, Profibus DP, IEC 60870-5-103, IEC 60870-5-101, IEC 61850, SPA bus, Ethernet / IP and DNP 3.0.

1.3.1 User interface

The relay can be controlled in three ways:

- Locally with the push-buttons on the relay front panel
- Locally using a PC connected to the serial port on the front panel or on the rear panel of the relay (both cannot be used simultaneously)
- Via remote control over the optional remote control port on the relay rear panel.

1.4 Related documents

Document	Identification*)
VAMP Relay Mounting and Commissioning Instructions	VRELAY_MC_XXXX
VAMPSET Setting and Configuration Tool User Manual	VVAMPSET_EN_M_XXXX

*) XXXX = revision number

Download the latest software and manual at
www.schneider-electric.com/vamp-protection or m.vamp.fi.

1.5 Periodical testing

The protection IED, cabling and arc sensors must periodically be tested according to the end-user's safety instructions, national safety instructions or law. Manufacturer recommends functional testing being carried minimum every five (5) years.

It is proposed that the periodic testing is conducted with a secondary injection principle for those protection stages which are used in the IED and its related units.

1.6 EU directive compliance

EMC compliance

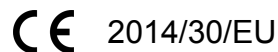

Compliance with the European Commission's EMC Directive. Product Specific Standards were used to establish conformity:

- EN 60255-26: 2013

Product safety

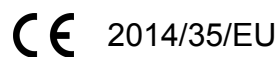

Compliance with the European Commission's Low Voltage Directive. Compliance is demonstrated by reference to generic safety standards:

- EN60255-27:2014

1.7 Abbreviations

ANSI	American National Standards Institute. A standardization organisation.
CB	Circuit breaker
CBFP	Circuit breaker failure protection
$\cos\phi$	Active power divided by apparent power = P/S. (See power factor PF). Negative sign indicates reverse power.
CT	Current transformer
CT_{PRI}	Nominal primary value of current transformer
CT_{SEC}	Nominal secondary value of current transformer
Dead band	See hysteresis.
DI	Digital input
DO	Digital output, output relay
Document file	Stores information about the IED settings, events and fault logs.
DSR	Data set ready. An RS232 signal. Input in front panel port of VAMP relays to disable rear panel local port.
DST	Daylight saving time. Adjusting the official local time forward by one hour for summer time.
DTR	Data terminal ready. An RS232 signal. Output and always true (+8 Vdc) in front panel port of VAMP relays.
FFT	Fast Fourier transform. Algorithm to convert time domain signals to frequency domain or to phasors.
HMI	Human-machine interface
Hysteresis	I.e. dead band. Used to avoid oscillation when comparing two near by values.
I_N	Nominal current. Rating of CT primary or secondary.
I_{SET}	Another name for pick up setting value $I>$
I_{0N}	Nominal current of I_0 input in general
I_{01N}	Nominal current of the I_{01} input of the device
I_{02N}	Nominal current of the I_{02} input of the device
IEC	International Electrotechnical Commission. An international standardization organisation.
IEC-101	Abbreviation for communication protocol defined in standard IEC 60870-5-101
IEC-103	Abbreviation for communication protocol defined in standard IEC 60870-5-103
IED	Intelligent electronic device, VAMP 265 is referenced in this document,
IEEE	Institute of Electrical and Electronics Engineers
LAN	Local area network. Ethernet based network for computers and IEDs.
Latching	Output relays and indication LEDs can be latched, which means that they are not released when the control signal is releasing. Releasing of latched devices is done with a separate action.
LCD	Liquid crystal display
LED	Light-emitting diode
Local HMI	IED front panel with display and push-buttons
NTP	Network Time Protocol for LAN and WWW
PT	See VT
pu	Per unit. Depending of the context the per unit refers to any nominal value. For example for overcurrent setting $1 \text{ pu} = 1 \times I_N$.
RMS	Root mean square
SF	IED status inoperative

SNTP	Simple Network Time Protocol for LAN and WWW
TCS	Trip circuit supervision
THD	Total harmonic distortion
UTC	Coordinated Universal Time (used to be called GMT = Greenwich Mean Time)
VAMPSET	Configuration tool for VAMP protection devices
Webset	http configuration interface
VT	Voltage transformer i.e. potential transformer PT

2 Local panel user interface

2.1 Relay front panel

The figure below shows, as an example, the front panel of the device and the location of the user interface elements used for local control.



1. Navigation push-buttons
2. LED indicators
3. LCD
4. RS 232 serial communication port for PC

Navigation push-button function



CANCEL push-button for returning to the previous menu. To return to the first menu item in the main menu, press the button for at least three seconds.



INFO push-button for viewing additional information, for entering the password view and for adjusting the LCD contrast.



ENTER push-button for activating or confirming a function.



arrow UP navigation push-button for moving up in the menu or increasing a numerical value.



arrow DOWN navigation push-button for moving down in the menu or decreasing a numerical value.



arrow LEFT navigation push-button for moving backwards in a parallel menu or selecting a digit in a numerical value.









arrow RIGHT navigation push-button for moving forwards in a parallel menu or selecting a digit in a numerical value.

LED indicators

The relay is provided with eight LED indicators:

LED indicator	Meaning	Measure/ Remarks
Power LED lit	The auxiliary power has been switched on	Normal operation state
Error LED lit	Internal fault, operates in parallel with the self-supervision output relay	The relay attempts to reboot [REBOOT]. If the error LED remains lit, call for maintenance.
Com LED lit or flashing	The serial bus is in use and transferring information	Normal operation state
Alarm LED lit	One or several signals of the output relay matrix have been assigned to output AL and the output has been activated by one of the signals. (For more information about output matrix, please see Chapter 2.4.5 Configuring digital outputs DO).	The LED is switched off when the signal that caused output AL to activate, e.g. the START signal, is reset. The resetting depends on the type of configuration, connected or latched.
Trip LED lit	One or several signals of the output relay matrix have been assigned to output Tr, and the output has been activated by one of the signals. (For more information about output relay configuration, please see Chapter 2.4.5 Configuring digital outputs DO).	The LED is switched off when the signal that caused output Tr to activate, e.g. the TRIP signal, is reset. The resetting depends on the type of configuration, connected or latched.
A- C LED lit	Application-related status indicators.	Configurable

Adjusting LCD contrast

1. On the local HMI, push  and .
2. Enter the four-digit password and push .
3. Push  and adjust the contrast.
 - To increase the contrast, push .
 - To decrease the contrast, push .
4. To return to the main menu, push .

Resetting latched indicators and output relays

All the indicators and output relays can be given a latching function in the configuration.

There are several ways to reset latched indicators and relays:

- From the alarm list, move back to the initial display by pushing  for approx. 3s. Then reset the latched indicators and output relays by pushing **OK**.
- Acknowledge each event in the alarm list one by one by pushing **OK** equivalent times. Then, in the initial display, reset the latched indicators and output relays by pushing **OK**.

The latched indicators and relays can also be reset via a remote communication bus or via a digital input configured for that purpose.

2.1.1

Display

The relay is provided with a backlit 128x64 LCD dot matrix display. The display enables showing 21 characters in one row and eight rows at the same time. The display has two different purposes: one is to show the single line diagram of the relay with the object status, measurement values, identification etc (Figure 2.1). The other purpose is to show the configuration and parameterization values of the relay (Figure 2.2).

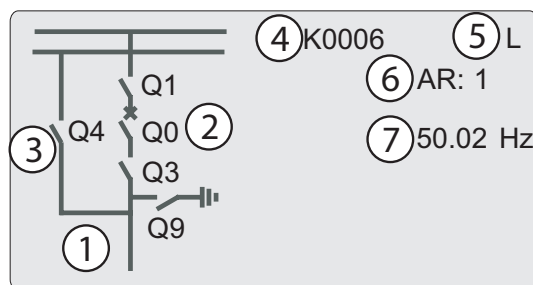

Figure 2.1: Sections of the LCD dot matrix display

1. Freely configurable single-line diagram
2. Controllable objects (max six objects)
3. Object status (max eight objects, including the six controllable objects)
4. Bay identification
5. Local/Remote selection
6. Auto-reclose on/off selection (if applicable)
7. Freely selectable measurement values (max. six values)

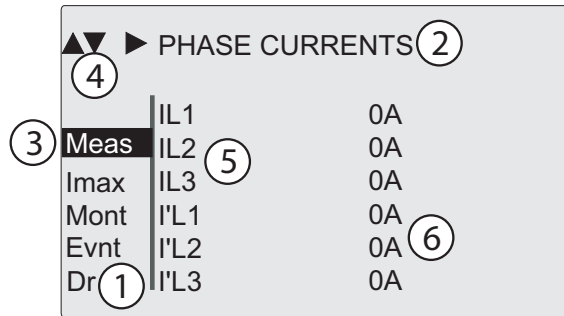

Figure 2.2: Sections of the LCD dot matrix display

1. Main menu column
2. The heading of the active menu
3. The cursor of the main menu
4. Possible navigating directions (push buttons)
5. Measured/setting parameter
6. Measured/set value

Backlight control

Display backlight can be switched on with a digital input, virtual input or virtual output. LOCALPANEL CONF/**Display backlight ctrl** setting is used for selecting trigger input for backlight control. When the selected input activates (rising edge), display backlight is set on for 60 minutes.

2.1.2

Adjusting display contrast

The readability of the LCD varies with the brightness and the temperature of the environment. The contrast of the display can be adjusted via the PC user interface, see Chapter 3 VAMPSET PC software.

2.2 Local panel operations

The front panel can be used to control objects, change the local/remote status, read the measured values, set parameters, and to configure relay functions. Some parameters, however, can only be set by means of a PC connected to the local communication port. Some parameters are factory-set.

Moving in the menus

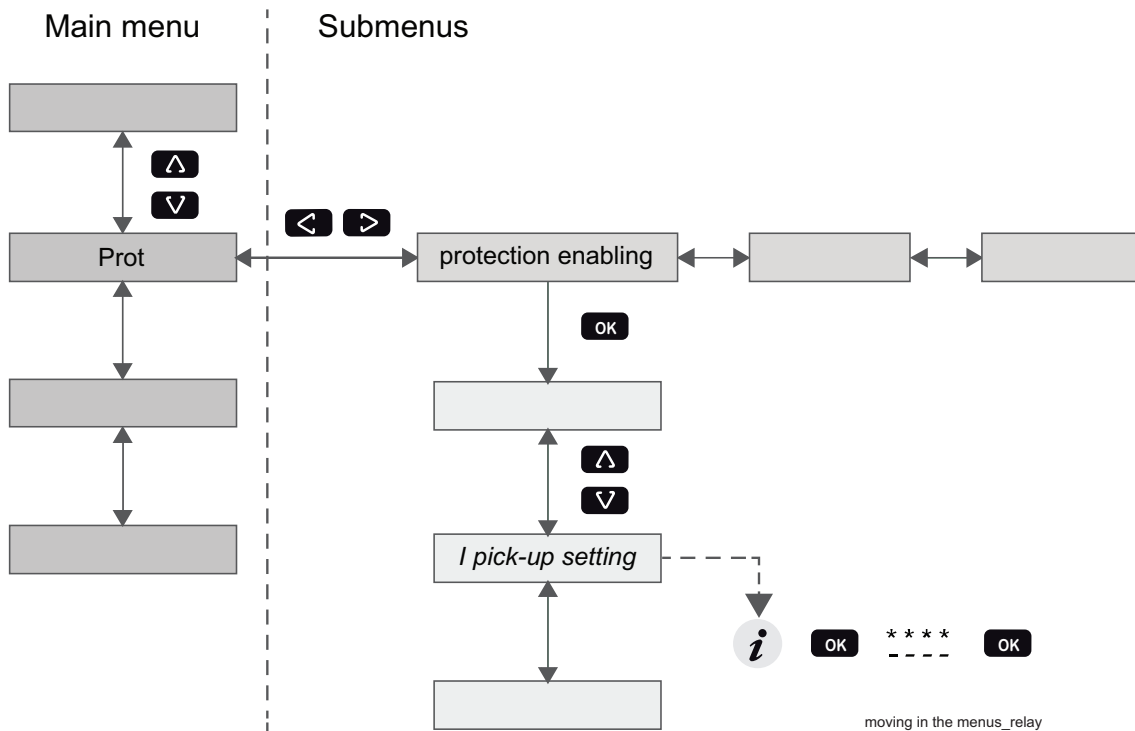

Figure 2.3: Moving in the menus using local HMI

- To move in the main menu, push or .
- To move in submenus, push or .
- To enter a submenu, push and use or for moving down or up in the menu.
- To edit a parameter value, push and .
- To go back to the previous menu, push .
- To go back to the first menu item in the main menu, push for at least three seconds.

NOTE: To enter the parameter edit mode, give the password. When the value is in edit mode, its background is dark.

Main menu

The menu is dependent on the user's configuration and the options according the order code. For example only the enabled protection stages will appear in the menu.

A list of the local main menu

Main menu	Number of menus	Description	ANSI code	Note
	1	Interactive mimic display		1
	5	Double size measurements defined by the user		1
	1	Title screen with device name, time and firmware version.		
I	13	Current measurements		
Dema	15	Demand values		
Umax	5	Time stamped min & max of voltages		
Imax	9	Time stamped min & max of currents		
Month	21	Maximum values of the last 31 days and the last twelve months		
Evnt	2	Events		
DR	2	Disturbance recorder		2
Runh	2	Running hour counter. Active time of a selected digital input and time stamps of the latest start and stop.		
TIMR	6	Day and week timers		
DI	5	Digital inputs including virtual inputs		
DO	4	Digital outputs (relays) and output matrix		
ExtAI	3	External analogue inputs		3
ExtAO	3	External analogue outputs		3
ExDI	3	External digital inputs		3
ExDO	3	External digital outputs		3
Prot	27	Protection counters, combined overcurrent status, protection status, protection enabling, cold load and inrush detectionIf2> and block matrix		
ΔI>	7	1st differential stages		
ΔI>>	5	2nd differential stage		
I>	5	1st overcurrent stage (primary side)	50/51	4
I>>	3	2nd overcurrent stage (primary side)	50/51	4
I'>	5	1st overcurrent stage (secondary side)	50/51	4
I'>>	3	2nd overcurrent stage (secondary side)	50/51	4
I2>	3	Current unbalance stage (primary side)	46	4
I'2>	3	Current unbalance stage (secondary side)	46	4
T>	3	Thermal overload stage	49	4
Io>	5	1st earth fault stage	50N/51N	4
Io>>	3	2nd earth fault stage	50N/51N	4
Io>>>	3	3rd earth fault stage	50N/51N	4
Io>>>>	3	4th earth fault stage	50N/51N	4

Main menu	Number of menus	Description	ANSI code	Note
Prg1	3	1st programmable stage		4
Prg2	3	2nd programmable stage		4
Prg3	3	3rd programmable stage		4
Prg4	3	4th programmable stage		4
Prg5	3	5th programmable stage		4
Prg6	3	6th programmable stage		4
Prg7	3	7th programmable stage		4
Prg8	3	8th programmable stage		4
If2>	3	Second harmonic O/C stage	68F2	4
If5>	3	Fifth harmonic O/C stage	68F5	4
CBFP	3	Circuit breaker failure protection	50BF	4
CBWE	4	Circuit breaker wearing supervision		4
CTSV	1	CT supervisor		4
CT'SV	1	CT' supervisor		4
ArcI>	4	Optional arc protection stage for phase-to-phase faults and delayed light signal.	50ARC	4
ArcI01>	3	Optional arc protection stage for earth faults. Current input = I01	50NARC	4
ArcI02>	3	Optional arc protection stage for earth faults. Current input = I02	50NARC	4
OBJ	11	Object definitions		5
Lgic	2	Status and counters of user's logic		1
CONF	10+2	Device setup, scaling etc.		6
Bus	13	Serial port and protocol configuration		7
Diag	6	Device selfdiagnosis		

Notes

1. Configuration is done with VAMPSET
2. Recording files are read with VAMPSET
3. The menu is visible only if protocol "ExternalIO" is selected for one of the serial ports. Serial ports are configured in menu "Bus".
4. The menu is visible only if the stage is enabled.
5. Objects are circuit breakers, disconnectors etc. Their position or status can be displayed and controlled in the interactive mimic display.
6. There are two extra menus, which are visible only if the access level "operator" or "configurator" has been opened with the corresponding password.
7. Detailed protocol configuration is done with VAMPSET.

2.2.1 Menu structure of protection functions

The general structure of all protection function menus is similar although the details do differ from stage to stage. As an example the details of the second overcurrent stage I>> menus are shown below.

▲▼ ▶ I>> STATUS		50 / 51
ExDO	Status	-
Prot	SCntr	5
I>	TCntr	2
I>>	SetGrp	1
Iv>	SGrpDI	-
Iφ>	Force	OFF

Figure 2.4: First menu of I>> 50/51 stage

This is the status, start and trip counter and setting group menu.

- Status –
The stage is not detecting any fault at the moment. The stage can also be forced to pick-up or trip if the operating level is “Configurator” and the force flag below is on. Operating levels are explained in Chapter 2.2.4 Operating levels.
- SCntr 5
The stage has picked-up a fault five times since the last reset or restart. This value can be cleared if the operating level is at least “Operator”.
- TCntr 1
The stage has tripped two times since the last reset or restart. This value can be cleared if the operating level is at least “Operator”.
- SetGrp 1
The active setting group is one. This value can be edited if the operating level is at least “Operator”. Setting groups are explained in Chapter 2.2.2 Setting groups
- SGrpDI –
The setting group is not controlled by any digital input. This value can be edited if the operating level is at least “Configurator”.
- Force Off
The status forcing and output relay forcing is disabled. This force flag status can be set to “On” or back to “Off” if the operating level is at least “Configurator”. If no front panel button is pressed within five minutes and there is no VAMPSET communication, the force flag will be set to “Off” position. The forcing is explained in Chapter 2.3.4 Forced control (Force).

▲▼◀▶	I>> SET	50 / 51
Stage	setting	group 1
ExDI	ILmax	403A
ExDO	Status	-
Prot	I>>	1013A
I>>	I>>	2.50xIn
CBWE	t>>	0.60s
OBJ		

Figure 2.5: Second menu(next on the right) of I>> 50/51 stage

This is the main setting menu.

- Stage setting group 1
These are the group 1 setting values. The other setting group can be seen by pressing push buttons **OK** and then **▶** or **◀**. Setting groups are explained in Chapter 2.2.2 Setting groups.
- ILmax 403A
The maximum of three measured phase currents is at the moment 403 A. This is the value the stage is supervising.
- Status –
Status of the stage. This is just a copy of the status value in the first menu.
- I>> 1013 A
The pick-up limit is 1013 A in primary value.
- I>> 2.50 x I_N
The pick-up limit is 2.50 times the rated current of the generator. This value can be edited if the operating level is at least “Operator”. Operating levels are explained in Chapter 2.2.4 Operating levels.
- t>> 0.60s
The total operation delay is set to 600 ms. This value can be edited if the operating level is at least “Operator”.

▲▼◀	I>> LOG	50/51
FAULT	LOG 1	
ExDI	2006-09-14	
ExDO	12:25:10.288	
Prot	Type 1-2	
I>>	Flt 2.86xI _N	
CBWE	Load 0.99xI _N	
OBJ	EDly 81%	
	SetGrp 1	

Figure 2.6: Third and last menu (next on the right) of I>> 50/51 stage

This is the menu for registered values by the I>> stage. Fault logs are explained in Chapter 2.2.3 Fault logs.

- **FAULT LOG 1**
This is the latest of the eight available logs. You may move between the logs by pressing push buttons **OK** and then **▶** or **◀**.
- **2006-09-14**
Date of the log.
- **12:25:10.288**
Time of the log.
- **Type 1-2**
The overcurrent fault has been detected in phases L1 and L2 (A & B, red & yellow, R/S, u&v).
- **Flt 2.86 x I_N**
The fault current has been 2.86 per unit.
- **Load 0.99 x I_N**
The average load current before the fault has been 0.99 pu.
- **EDly 81%**
The elapsed operation delay has been 81% of the setting 0.60 s = 0.49 s. Any registered elapsed delay less than 100 % means that the stage has not tripped, because the fault duration has been shorter than the delay setting.
- **SetGrp 1**
The setting group has been 1. This line can be reached by pressing **OK** and several times **▼**.

2.2.2 Setting groups

Most of the protection functions of the relay have four setting groups. These groups are useful for example when the network topology is changed frequently. The active group can be changed by a digital

input, through remote communication or locally by using the local panel.

The active setting group of each protection function can be selected separately. Figure 2.7 shows an example where the changing of the I> setting group is handled with digital input one (SGrpDI). If the digital input is TRUE, the active setting group is group two and correspondingly, the active group is group one, if the digital input is FALSE. If no digital input is selected (SGrpDI = -), the active group can be selected by changing the value of the parameter SetGrp.

▲▼ ▶ I> STATUS		51
Evnt	Status	-
DR	SCntr	0
DI	TCntr	0
DO	SetGrp	1
Prot	SGrpDI	DI1
I>	Force	OFF

Figure 2.7: Example of protection submenu with setting group parameters

The changing of the setting parameters can be done easily. When the desired submenu has been found (with the arrow keys), press **OK** to select the submenu. Now the selected setting group is indicated in the down-left corner of the display (See Figure 2.8). Set1 is setting group one and Set2 is setting group two. When the needed changes, to the selected setting group, have been done, press **▶** or **◀** to select another group (**◀** is used when the active setting group is 2 and **▶** is used when the active setting group is 1).

SET I>		51
Setting for stage I>		
	ILmax	400 A
	Status	-
	I>	600 A
Set1	I>	1.10xIn
I>	Type	DT
	t>	0.50 s

Figure 2.8: Example of I> setting submenu

2.2.3 Fault logs

All the protection functions include fault logs. The fault log of a function can register up to eight different faults with time stamp information, fault values etc. The fault logs are stored in non-volatile memory. Each function has its own logs. The fault logs are not cleared when power is switched off. The user is able to clear all logs using VAMPSET. Each function has its own logs (Figure 2.9).

▲▼◀▶	I> log buffer	51
Log	buffer 1	
DR	2003-04-28	
DI	11:11:52;251	
DO	Type	1-2
Prot	Flt	0.55 xIn
I>	Load	0.02 xIn
I>>	EDly	24 %

Figure 2.9: Example of fault log

To see the values of, for example, log two, press then **OK** to select the current log (log one). The current log number is then indicated in the down-left corner of the display (See Figure 2.10, Log2 = log two). The log two is selected by pressing **>** once.

	I> log buffer	
Date	2003-04-24	
	03:08:21;342	
	Type	1-2
Log2	Flt	1.69 xIn
I>	Load	0.95 xIn
	EDly	13 %

Figure 2.10: Example of selected fault log

2.2.4 Operating levels

The relay has three operating levels: **User level**, **Operator level** and **Configurator level**. The purpose of the access levels is to prevent accidental change of relay configurations, parameters or settings.

USER level

Use:	Possible to read e.g. parameter values, measurements and events
Opening:	Level permanently open
Closing:	Closing not possible

OPERATOR level

Use:	Possible to control objects and to change e.g. the settings of the protection stages
Opening:	Default password is 1
Setting state:	Push 
Closing:	The level is automatically closed after 10 minutes idle time. Giving the password 9999 can also close the level.

CONFIGURATOR level

Use:	The configurator level is needed during the commissioning of the relay. E.g. the scaling of the voltage and current transformers can be set.
Opening:	Default password is 2
Setting state:	Push 
Closing:	The level is automatically closed after 10 minutes idle time. Giving the password 9999 can also close the level.

Opening access

1. Push  and **OK** on the front panel

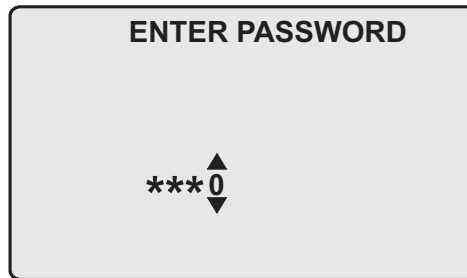



Figure 2.11: Opening the access level

2. Enter the password needed for the desired level: the password can contain four digits. The digits are supplied one by one by first moving to the position of the digit using  and then setting the desired digit value using .
3. Push **OK**.

Password handling

The passwords can only be changed using VAMPSET software connected to the local RS-232 port on the relay.

It is possible to restore the password(s) in case the password is lost or forgotten. In order to restore the password(s), a relay program is needed. The virtual serial port settings are 38400 bps, 8 data bits, no parity and one stop bit. The bit rate is configurable via the front panel.

Command	Description
get pwd_break	Get the break code (Example: 6569403)
get serno	Get the serial number of the relay (Example: 12345)

Send both the numbers to your nearest Schneider Electric Customer Care Centre and ask for a password break. A device specific break code is sent back to you. That code will be valid for the next two weeks.

Command	Description
set pwd_break=4435876	Restore the factory default passwords ("4435876" is just an example. The actual code should be asked from your nearest Schneider Electric Customer Care Centre.)

Now the passwords are restored to the default values (See Chapter 2.2.4 Operating levels).

2.3 Operating measures

2.3.1 Control functions

The default display of the local panel is a single-line diagram including relay identification, Local/Remote indication, Auto-reclose on/off selection and selected analogue measurement values.

Please note that the operator password must be active in order to be able to control the objects. Please refer to Chapter 2.2.4 Operating levels.

toggling Local/Remote control

1. Push **OK**. The previously activated object starts to blink.
2. Select the Local/Remote object (“L” or “R” squared) by using arrow keys.
3. Push **OK**. The L/R dialog opens. Select “REMOTE” to enable remote control and disable local control. Select “LOCAL” to enable local control and disable remote control.
4. Confirm the setting by pushing **OK**. The Local/Remote state will change.

Object control

1. Push **OK**. The previously activated object starts to blink.
2. Select the object to control by using arrow keys. Please note that only controllable objects can be selected.
3. Push **OK**. A control dialog opens.
4. Select the “Open” or “Close” command by using the **▲** or **▼**.
5. Confirm the operation by pushing **OK**. The state of the object changes.

toggling virtual inputs

1. Push **OK**. The previously activated object starts to blink.
2. Select the virtual input object (empty or black square)
3. The dialog opens
4. Select “Vlon” to activate the virtual input or select “Vloff” to deactivate the virtual input

2.3.2 Measured data

The measured values can be read from the main menus and their submenus. Furthermore, any measurement value in the following table can be displayed on the main view next to the single line diagram. Up to six measurements can be shown.

Value	Menu/Submenu	Description
f	P/POWER	Frequency [Hz]
IL1	I/PHASE CURRENTS	Phase current IL1 [A]
IL2	I/PHASE CURRENTS	Phase current IL2 [A]
IL3	I/PHASE CURRENTS	Phase current IL3 [A]
IL1da	I/PHASE CURRENTS	15 min average for IL1 [A]
IL2da	I/PHASE CURRENTS	15 min average for IL2 [A]
IL3da	I/PHASE CURRENTS	15 min average for IL3 [A]
I'L1	I/PHASE CURRENTS	Phase current I'L1 [A]
I'L2	I/PHASE CURRENTS	Phase current I'L2 [A]
I'L3	I/PHASE CURRENTS	Phase current I'L3 [A]
I'L1da	I/PHASE CURRENTS	15 min average for I'L1 [A]
I'L2da	I/PHASE CURRENTS	15 min average for I'L2 [A]
I'L3da	I/PHASE CURRENTS	15 min average for I'L3 [A]
Io	I/SYMMETRIC CURRENTS	Primary value of zero-sequence/ residual current Io [A]
Io2	I/SYMMETRIC CURRENTS	Primary value of zero-sequence/residual current Io2 [A]
IoC	I/SYMMETRIC CURRENTS	Calculated Io [A]
I1	I/SYMMETRIC CURRENTS	Positive sequence current [A]
I2	I/SYMMETRIC CURRENTS	Negative sequence current [A]
I2/I1	I/SYMMETRIC CURRENTS	Negative sequence current related to positive sequence current (for unbalance protection) [%]
I'1	I/SYMMETRIC CURRENTS	Positive sequence current [A]
I'2	I/SYMMETRIC CURRENTS	Negative sequence current [A]
I'2/I'1	I/SYMMETRIC CURRENTS	Negative sequence current related to positive sequence current (for unbalance protection) [%]
THDIL	I/HARM. DISTORTION	Total harmonic distortion of the mean value of phase currents [%]
THDIL1	I/HARM. DISTORTION	Total harmonic distortion of phase current IL1 [%]
THDIL2	I/HARM. DISTORTION	Total harmonic distortion of phase current IL2 [%]
THDIL3	I/HARM. DISTORTION	Total harmonic distortion of phase current IL3 [%]
THDI'L1	I/HARM. DISTORTION	Total harmonic distortion of phase current I'L1 [%]
THDI'L2	I/HARM. DISTORTION	Total harmonic distortion of phase current I'L2 [%]
THDI'L3	I/HARM. DISTORTION	Total harmonic distortion of phase current I'L3 [%]
Diagram	I/HARMONICS of IL1	Harmonics of phase current IL1 [%] (See Figure 2.12)
Diagram	I/HARMONICS of IL2	Harmonics of phase current IL2 [%] (See Figure 2.12)
Diagram	I/HARMONICS of IL3	Harmonics of phase current IL3 [%] (See Figure 2.12)
Diagram	I/HARMONICS of I'L1	Harmonics of phase current I'L1 [%] (See Figure 2.12)
Diagram	I/HARMONICS of I'L2	Harmonics of phase current I'L2 [%] (See Figure 2.12)
Diagram	I/HARMONICS of I'L3	Harmonics of phase current I'L3 [%] (See Figure 2.12)

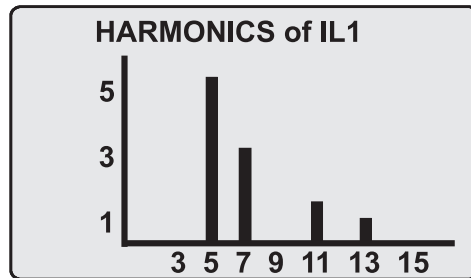

Figure 2.12: Example of harmonics bar display

2.3.3 Reading event register

The event register can be read from the Evnt submenu:





1. Push  once.
2. The EVENT LIST appears. The display contains a list of all the events that have been configured to be included in the event register.



Figure 2.13: Example of an event register

3. Scroll through the event list with the  and .
4. Exit the event list by pushing .

It is possible to set the order in which the events are sorted. If the "Order" -parameter is set to "New-Old", then the first event in the EVENT LIST is the most recent event.

2.3.4 Forced control (Force)

In some menus it is possible to switch a function on and off by using a force function. This feature can be used, for instance, for testing a certain function. The force function can be activated as follows:

1. Open access level Configurator.
2. Move to the setting state of the desired function, for example DO (see Chapter 2.4 Configuration and parameter setting).
3. Select the Force function (the background color of the force text is black).

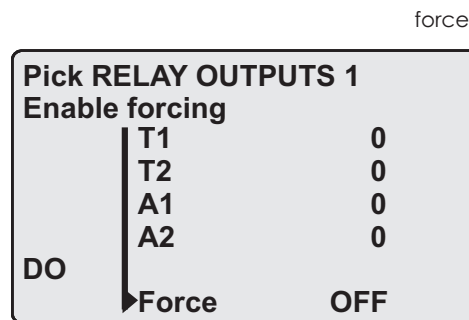

Figure 2.14: Selecting Force function

4. Push **OK**.
5. Push the **▲** or **▼** to change the "OFF" text to "ON", that is, to activate the Force function.
6. Push **OK** to return to the selection list. Choose the signal to be controlled by force with the **▲** and **▼**, for instance the T1 signal.
7. Push **OK** to confirm the selection. Signal T1 can now be controlled by force.
8. Push the **▲** or **▼** to change the selection from "0" (not alert) to "1" (alert) or vice versa.
9. Push **OK** to execute the forced control operation of the selected function, e.g., making the output relay of T1 to pick up.
10. Repeat the steps 7 and 8 to alternate between the on and off state of the function.
11. Repeat the steps 1 – 4 to exit the Force function.
12. Push **🏠** to return to the main menu.

NOTE: All the interlockings and blockings are bypassed when the force control is used.

2.4 Configuration and parameter setting

The minimum procedure to configure a device is

1. Open the access level "Configurator". The default password for configurator access level is 2.
2. Set the rated values in menu [CONF] including at least current transformers and a protected transformer rating. Also the date and time settings are in this same main menu.
3. Enable the needed protection functions and disable the rest of the protection functions in main menu [Prot].
4. Set the setting parameter of the enable protection stages according the application.
5. Connect the output relays to the start and trip signals of the enabled protection stages using the output matrix. This can be done in main menu [DO], although the VAMPSET program is recommended for output matrix editing.
6. Configure the needed digital inputs in main menu [DI].
7. Configure blocking and interlockings for protection stages using the block matrix. This can be done in main menu [Prot], although VAMPSET is recommended for block matrix editing.

Some of the parameters can only be changed via the RS-232 serial port using the VAMPSET software. Such parameters, (for example passwords, blockings and mimic configuration) are normally set only during commissioning.

Some of the parameters require the restarting of the relay. This restarting is done automatically when necessary. If a parameter change requires restarting, the display will show as Figure 2.15

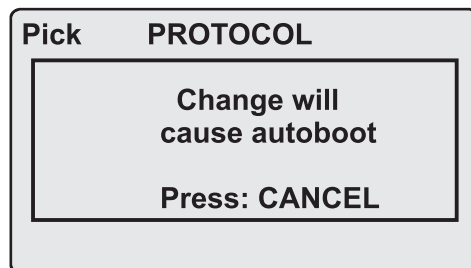





Figure 2.15: Example of auto-reset display

Press  to return to the setting view. If a parameter must be changed, press  again. The parameter can now be set. When the parameter change is confirmed with , a [RESTART]- text appears to the top-right corner of the display. This means that auto-resetting is pending. If no key is pressed, the auto-reset will be executed within few seconds.

2.4.1 Parameter setting

1. Move to the setting state of the desired menu (for example CONF/CURRENT SCALING) by pushing **OK**. The Pick text appears in the upper-left part of the display.
2. Enter the password associated with the configuration level by pushing **i** and then using the arrow keys and **OK** (default value is 0002). For more information about the access levels, please refer to Chapter 2.2.3 Fault logs.
3. Scroll through the parameters using the **▲** and **▼**. A parameter can be set if the background color of the line is black. If the parameter cannot be set the parameter is framed.
4. Select the desired parameter (for example Inom) with **OK**.
5. Use the **▲** and **▼** keys to change a parameter value. If the value contains more than one digit, use the **▶** and **◀** keys to shift from digit to digit, and the **▲** and **▼** keys to change the digits.
6. Push **OK** to accept a new value. If you want to leave the parameter value unchanged, exit the edit state by pushing **HOME**.

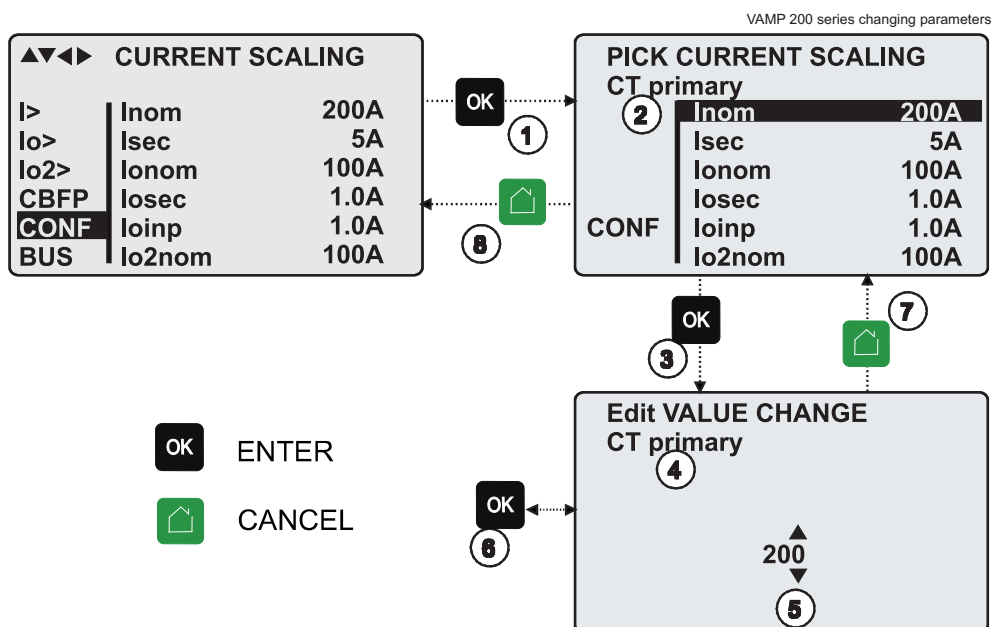

Figure 2.16: Changing parameters

2.4.2 Setting range limits

If the given parameter setting values are out-of-range values, a fault message will be shown when the setting is confirmed with **OK**. Adjust the setting to be within the allowed range.

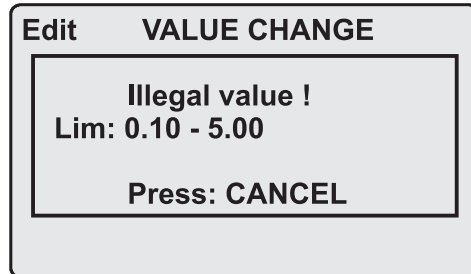



Figure 2.17: Example of a fault message

The allowed setting range is shown in the display in the setting mode. To view the range, push . Push  to return to the setting mode.

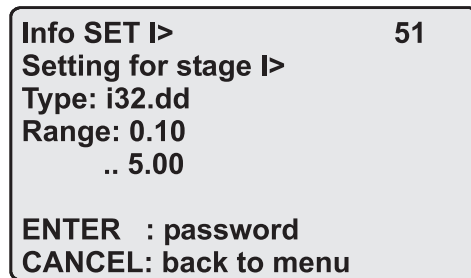

Figure 2.18: Allowed setting ranges show in the display

2.4.3 Disturbance recorder menu DR

Via the submenus of the disturbance recorder menu the following functions and features can be read and set:

Disturbance settings

1. Manual trigger (ManTrg)
2. Status (Status)
3. Clear oldest record (Clear)
4. Clear all records (ClrAll)
5. Recording completion (Stored)
6. Count of ready records (ReadyRec)

Recorder settings

1. Manual trigger (MnlTrig)
2. Sample rate (Rate)
3. Recording time (Time)
4. Pre trig time (PreTrig)
5. Mximum time (MaxLen)
6. Count of ready records (ReadyRe)

Rec. coupling

- Add a link to the recorder (AddLink)
- Clear all links (ClrLnks)

Available links

- DO, DI
- IL, I'L
- I2/In, I2/I1, I2, I1, IoCalc, I2/In, I'2/I'1, I'2, I'1, I'oCalc
- f
- IL3, IL2, IL1, I'L3, I'L2, I'L1
- IL1RMS, IL2RMS, IL3RMS
- ILmin, ILmax, I'Lmin, I'Lmax
- Io2, Io1
- Δ IL1, Δ IL2, Δ IL3
- IL1w, IL2w, IL3w, I'L1w, I'L2w, I'L3w

2.4.4 Configuring digital inputs DI

The following functions can be read and set via the submenus of the digital inputs menu:

1. The status of digital inputs (DIGITAL INPUTS 1 – 6)
2. Operation counters (DI COUNTERS)
3. Operation delay (DELAYs for DigIn)
4. The polarity of the input signal (INPUT POLARITY). Either normally open (NO) or normally closed (NC) circuit.
5. Event enabling EVENT MASK1

2.4.5 Configuring digital outputs DO

The following functions can be read and set via the submenus of the digital outputs menu:

- The status of the output relays (RELAY OUTPUTS1 and 2)
- The forcing of the output relays (RELAY OUTPUTS1 and 2) (only if Force = ON):
 - Forced control (0 or 1) of the Trip relays
 - Forced control (0 or 1) of the Alarm relays
 - Forced control (0 or 1) of the SF relay
- The configuration of the output signals to the output relays. The configuration of the operation indicators (LED) Alarm and Trip and application specific alarm leds A, B and C (that is, the output relay matrix).

NOTE: The amount of Trip and Alarm relays depends on the relay type and optional hardware.

2.4.6 Protection menu Prot

The following functions can be read and set via the submenus of the Prot menu:

1. Reset all the counters (PROTECTION SET/CIAll)
2. Read the status of all the protection functions (PROTECT STATUS 1 – x)
3. Enable and disable protection functions (ENABLED STAGES 1 – x)
4. Define the interlockings using block matrix (only with VAMPSET)

Each stage of the protection functions can be disabled or enabled individually in the Prot menu. When a stage is enabled, it will be in operation immediately without a need to reset the relay.

The relay includes several protection functions. However, the processor capacity limits the number of protection functions that can be active at the same time.

2.4.7 Configuration menu CONF

The following functions and features can be read and set via the submenus of the configuration menu:

Device setup

- Bit rate for the command line interface in ports X4 and the front panel. The front panel is always using this setting. If SPABUS is selected for the rear panel local port X4, the bit rate is according SPABUS settings.
- Access level [Acc]
- PC access level [PCAcc]

Language

- List of available languages in the relay

Current scaling

- Rated phase CT primary current (I_{nom})
- Rated phase CT secondary current (I_{sec})
- Rated input of the relay [I_{input}]. 5 A or 1 A. This is specified in the order code of the device.
- Rated phase CT' primary current (I'_{nom})
- Rated phase CT' secondary current (I'_{sec})
- Rated input of the relay [I'_{input}]. 5 A or 1 A. This is specified in the order code of the device.
- Rated value of I_0 CT primary current (I_{0nom})
- Rated value of I_0 CT secondary current (I_{0sec})
- Rated I_{01} input of the relay [I_{0inp}]. 5 A or 1 A. This is specified in the order code of the device.
- Rated value of I_{02} CT primary current (I_{02nom})
- Rated value of I_{02} CT secondary current (I_{02sec})
- Rated I_{02} input of the relay [I_{02inp}]. 5A, 1 A or 0.2 A. This is specified in the order code of the device.

The rated input values are usually equal to the rated secondary value of the CT.

The rated CT secondary may be greater than the rated input but the continuous current must be less than four times the rated input. In compensated, high impedance earthed and isolated networks using cable transformer to measure residual current I_0 , it is quite usual to use a relay with 1 A or 0.2 A input although the CT is 5 A or 1A. This increases the measurement accuracy.

The rated CT secondary may also be less than the rated input but the measurement accuracy near zero current will decrease.

Transformer setting

- Rated voltage in IL side (typically high voltage side)
- Rated voltage in I'L side (typically low voltage side)
- Rated power of transformer
- Connection group of transformer
- Zero current compensation in IL side (If transformer is earthed in IL side, this must set as "ON")
- Zero current compensation in I'L side (If transformer is earthed in I'L side, this must set as "ON")
- Connection group of the unit transformer, if any. IEC marking with capital letters Y and D for HV side and small case letters y and d for LV side combined with the dial hour is used. For example Yd11 means a wye-delta transformer where the delta side phase-to-ground voltages are leading 30° the wye side phase-to-ground voltages.

Device info

- Relay type (Type VAMP 265)
- Serial number (SerN)
- Software version (PrgVer)
- Bootcode version (BootVer)

Date/time setup

- Day, month and year (Date)
- Time of day (Time)
- Date format (Style). The choices are "yyyy-mm-dd", "dd.nn.yyyy" and "mm/dd/yyyy".

Clock synchronisation

- Digital input for minute sync pulse (SyncDI). If any digital input is not used for synchronization, select "-".
- Daylight saving time for NTP synchronization (DST).
- Detected source of synchronization (SyScr).
- Synchronization message counter (MsgCnt).
- Latest synchronization deviation (Dev).

The following parameters are visible only when the access level is higher than "User".

- Offset, i.e. constant error, of the synchronization source (SyOS).
- Auto adjust interval (AAIntv).
- Average drift direction (AvDrft): "Lead" or "lag".
- Average synchronization deviation (FilDev).

SW options

- Application mode, fixed Motor (AppMod)
- External led module installed (Ledmodule)
- Mimic display selection (MIMIC)

2.4.8 Protocol menu Bus

There are three communication ports in the rear panel. In addition there is a connector in the front panel overruling the local port in the rear panel.

Remote port

- Communication protocol for remote port X5 [Protocol].
- Message counter [Msg#]. This can be used to verify that the device is receiving messages.
- Communication error counter [Errors]
- Communication time-out error counter [Tout].
- Information of bit rate/data bits/parity/stop bits. This value is not directly editable. Editing is done in the appropriate protocol setting menus.

The counters are useful when testing the communication.

Local port X4 (pins 2, 3 and 5)

This port is disabled, if a cable is connected to the front panel connector.

- Communication protocol for the local port X4 [Protocol]. For VAMPSET use "None" or "SPABUS".
- Message counter [Msg#]. This can be used to verify that the device is receiving messages.
- Communication error counter [Errors]
- Communication time-out error counter [Tout].
- Information of bit rate/data bits/parity/stop bits. This value is not directly editable. Editing is done in the appropriate protocol setting menus. For VAMPSET and protocol "None" the setting is done in menu CONF/DEVICE SETUP.

The counters are useful when testing the communication.

PC (Local/SPA-bus)

This is a second menu for local port X4. The VAMPSET communication status is showed.

- Bytes/size of the transmitter buffer [Tx].
- Message counter [Msg#]. This can be used to verify that the device is receiving messages.
- Communication error counter [Errors]
- Communication time-out error counter [Tout].
- Same information as in the previous menu.

Extension port (pins 7, 8 and 5)

- Communication protocol for extension port X4 [Protocol].
- Message counter [Msg#]. This can be used to verify that the device is receiving messages.
- Communication error counter [Errors]
- Communication time-out error counter [Tout].
- Information of bit rate/data bits/parity/stop bits. This value is not directly editable. Editing is done in the appropriate protocol setting menus.

Ethernet port

These parameters are used by the ethernet interface module. For changing the nnn.nnn.nnn.nnn style parameter values, VAMPSET is recommended.

- Ethernet port protocol [Protoc].
- IP Port for protocol [Port]
- IP address [IpAddr].
- Net mask [NetMsk].
- Gateway [Gatew].
- Name server [NameSw].
- Network time protocol (NTP) server [NTPSvr].
- TCP Keep alive interval [KeepAlive]
- MAC address [MAC]
- IP Port for VAMPSET [VS Port]
- Message counter [Msg#]
- Error counter [Errors]
- Timeout counter [Tout]

Modbus

- Modbus address for this slave device [Addr]. This address has to be unique within the system.
- Modbus bit rate [bit/s]. Default is "9600".
- Parity [Parity]. Default is "Even".

For details, see Chapter 9.2.2 Modbus TCP and Modbus RTU.

External I/O protocol

This is a Modbus master protocol to communicate with the extension I/O modules connected to the extension port. Only one instance of this protocol is possible.

- Bit rate [bit/s]. Default is "9600".
- Parity [Parity]. Default is "Even".

For details, see Chapter 9.2.8 External I/O (Modbus RTU master).

SPA-bus

Several instances of this protocol are possible.

- SPA-bus address for this device [Addr]. This address has to be unique within the system.
- Bit rate [bit/s]. Default is "9600".
- Event numbering style [Emode]. Default is "Channel".

For details, see Chapter 9.2.4 SPA-bus.

IEC 60870-5-103

Only one instance of this protocol is possible.

- Address for this device [Addr]. This address has to be unique within the system.
- Bit rate [bit/s]. Default is "9600".
- Minimum measurement response interval [MeasInt].
- ASDU6 response time mode [SyncRe].

For details, see Chapter 9.2.5 IEC 60870-5-103.

IEC 103 Disturbance recordings

For details, see Table 9.11.

Profibus

Only one instance of this protocol is possible.

- [Mode]
- Bit rate [bit/s]. Use 2400 bps. This parameter is the bit rate between the main CPU and the Profibus ASIC. The actual Profibus bit rate is automatically set by the Profibus master and can be up to 12 Mbit/s.
- Event numbering style [Emode].
- Size of the Profibus Tx buffer [InBuf].
- Size of the Profibus Rx buffer [OutBuf].
When configuring the Profibus master system, the length of these buffers are needed. The size of the both buffers is set indirectly when configuring the data items for Profibus.
- Address for this slave device [Addr]. This address has to be unique within the system.
- Profibus converter type [Conv]. If the shown type is a dash "-", either Profibus protocol has not been selected or the device has not restarted after protocol change or there is a communication problem between the main CPU and the Profibus ASIC.

For details, see Chapter 9.2.3 Profibus DP.

DNP3

Only one instance of this protocol is possible.

- Bit rate [bit/s]. Default is "9600".
- [Parity].
- Address for this device [SlvAddr]. This address has to be unique within the system.
- Master's address [MstrAddr].

For details, see Chapter 9.2.6 DNP 3.0.

IEC 60870-5-101

- Bit rate [bit/s]. Default is "9600".
- [Parity].
- Link layer address for this device [LLAddr].
- ASDU address [ALAddr].

For details, see Chapter 9.2.7 IEC 60870-5-101.

DeviceNet

- Bit rate [bit/s]. Default is "125kbps".
- Slave address [SlvAddr]

For details, see Chapter 9.2.12 DeviceNet.

2.4.9**Single line diagram editing**

The single-line diagram is drawn with the VAMPSET software. For more information, please refer to the VAMPSET manual (VVAMPSET/EN M/xxxx).

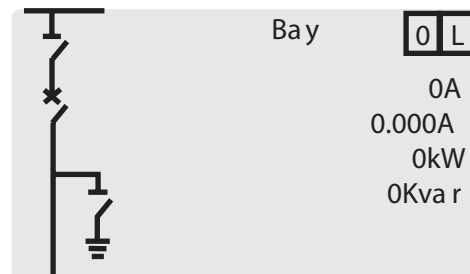

Figure 2.19: Single line diagram

2.4.10

Blocking and Interlocking configuration

The configuration of the blockings and interlockings is done with the VAMPSET software. Any start or trip signal can be used for blocking the operation of any protection stage. Furthermore, the interlocking between objects can be configured in the same blocking matrix of the VAMPSET software. For more information, please refer to the VAMPSET manual (VVAMPSET/EN M/xxxx).

3 VAMPSET PC software

The PC user interface can be used for:

- On-site parameterization of the relay
- Loading relay software from a computer
- Reading measured values, registered values and events to a computer
- Continuous monitoring of all values and events

Two RS 232 serial ports are available for connecting a local PC with VAMPSET to the relay; one on the front panel and one on the rear panel of the relay. These two serial ports are connected in parallel. However, if the connection cables are connected to both ports, only the port on the front panel will be active. To connect a PC to a serial port, use a connection cable of type VX 003-3.

The VAMPSET program can also use TCP/IP LAN connection. Optional hardware is required.

There is a free of charge PC program called VAMPSET available for configuration and setting of VAMP relays. Please download the latest VAMPSET.exe from our web page. For more information about the VAMPSET software, please refer to the user's manual with the code VVAMPSET/EN M/xxxx. Also the VAMPSET user's manual is available at our web site.

3.1 Folder view

In VAMPSET version 2.2.136, a feature called "Folder view" was introduced.

The idea of folder view is to make it easier for the user to work with relay functions inside VAMPSET. When folder view is enabled, VAMPSET gathers similar functions together and places them appropriately under seven different folders (GENERAL, MEASUREMENTS, INPUTS/OUTPUTS, MATRIX, LOGS and COMMUNICATION). The contents (functions) of the folders depend on the relay type and currently selected application mode.

Folder view can be enabled in VAMPSET via Program Settings dialog (Settings -> Program Settings), see Figure 3.1.

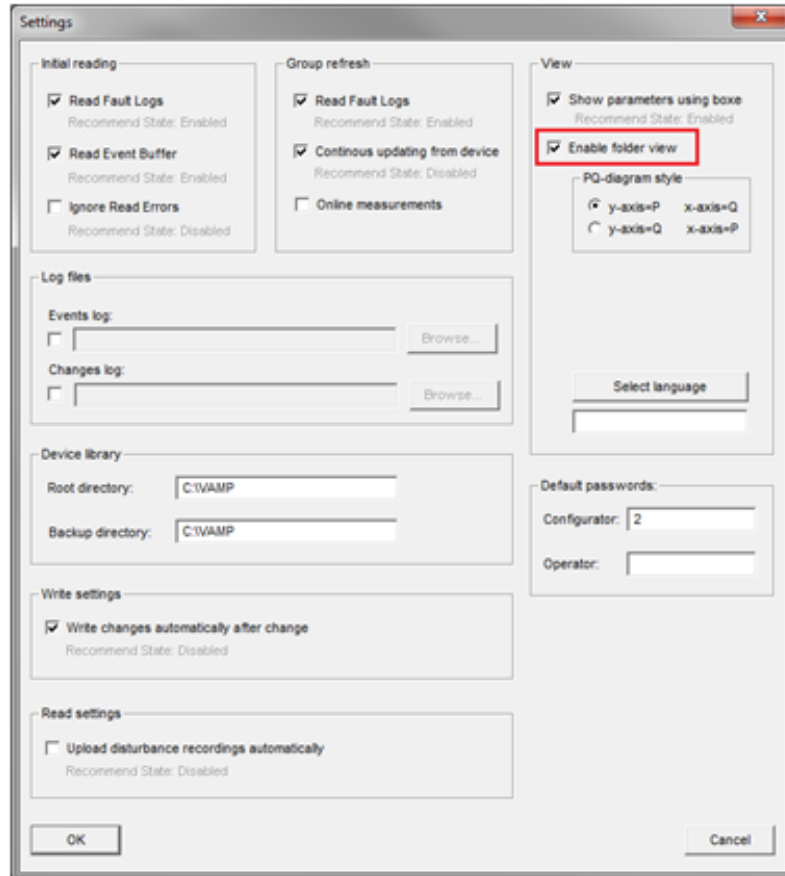

Figure 3.1: Enable folder view setting in Program Settings dialog

NOTE: It is possible to enable/ disable the folder view only when VAMPSET is disconnected from the relay and there is no configuration file opened.

When folder view is enabled, folder buttons become visible in VAMPSET, see Figure 3.2. Currently selected folder appears in bold.



Figure 3.2: Folder view buttons

4 Introduction

The numerical VAMP differential protection include all the essential protection functions needed to protect transformers for distribution networks of utilities, industry, power plants and offshore applications as well as motor and generator differential protection. Further, the device includes several programmable functions, such as arc (option), thermal and circuit breaker protection and communication protocols for various protection and communication situations. VAMP 265 can be used for selective differential overcurrent, short-circuit protection of generators, trans-formers and motors in solidly or impedance earthed power systems. The relay can also be used for single, two or three-phase overcurrent and/or sensitive earth fault protection.

4.1 Main features

- Fully digital signal handling with a powerful 16-bit microprocessor, and high measuring accuracy on all the setting ranges due to an accurate 16-bit A/D conversion technique.
- Wide setting ranges for the protection functions, e.g. the earth fault protection can reach a sensitivity of 0.5%.
- The device can be matched to the requirements of the application by disabling the functions that are not needed.
- Flexible control and blocking possibilities due to digital signal control inputs (DI) and outputs (DO).
- Easy adaptability of the device to various substations and alarm systems due to flexible signal-grouping matrix in the device.
- Freely configurable display with six measurement values.
- Freely configurable interlocking schemes with basic logic functions.
- Recording of events and fault values into an event register from which the data can be read via a keypad and a local HMI or by means of a PC based VAMPSET user interface.
- Latest events and indications are in non-volatile memory.
- Easy configuration, parameterisation and reading of information via local HMI, or with a VAMPSET user interface.
- Easy connection to power plant automation system due to a versatile serial connection and several available communication protocols.
- Built-in, self-regulating ac/dc converter for auxiliary power supply from any source within the range from 40 to 265 Vdc or Vac. The alternative power supply is for 18 to 36 Vdc.

- Built-in disturbance recorder for evaluating all the analogue and digital signals.
- Eight (8) programmable stages for alarming or protection purposes

4.2 Principles of numerical protection techniques

The device is using numerical technology. This means that all the signal filtering, protection and control functions are implemented through digital processing.

The numerical technique is primarily based on an adapted Fast Fourier Transformation (FFT) algorithm. Synchronized sampling of the measured voltage and current signals is used. The sample rate is 32 samples/cycle within the frequency range 45 Hz – 65 Hz. The frequency is measured from the voltage signals and used to synchronize the sampling rate.

Therefore secondary testing of a brand new device should be started with voltage protection functions and voltage injection to let the relay learn the local frequency. The learned frequency is used for sampling rate synchronization when no voltage is present. The local network frequency can also be manually given for the relay.

Apart from the FFT calculations, some protection functions also require the symmetrical components to be calculated for obtaining the positive, negative and zero phase sequence components of the measured quantity. For example, the function of the unbalanced load protection stage is based on the use of the negative phase sequence component of the current.

Figure 4.1 shows a hardware block diagram of the relay. The main components are the current and voltage inputs, digital input elements, output relays, A/D converters and the microcomputer and a power supply unit.

Figure 4.2 shows the inputs and outputs of a general protection function. The FFT block is calculating the fundamental frequency phasors and also harmonics used by some protection functions. The block matrix is used for simple interlocking. (More complex interlocking is done with the user's programmable logic). The output matrix is used to connect the pick-up and trip signals from protection blocks to the output relays and indicators.

Figure 4.3 shows a block diagram of a basic overcurrent or overvoltage function with definite and inverse operation time.

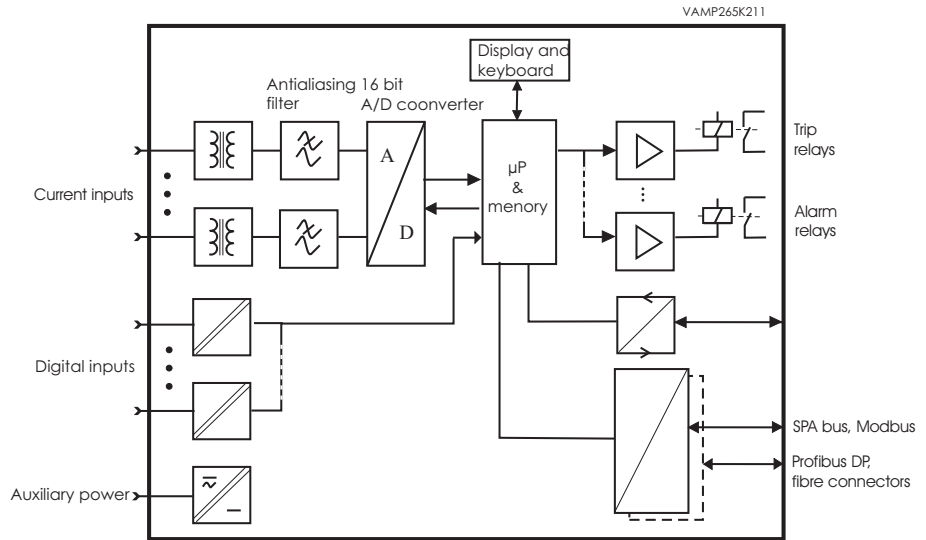

Figure 4.1: Principle block diagram of the VAMP hardware

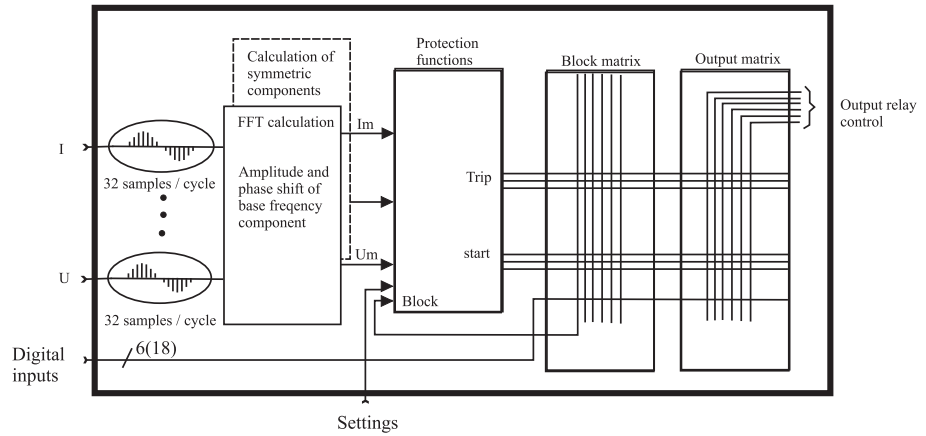

Figure 4.2: Block diagram of signal processing and protection software

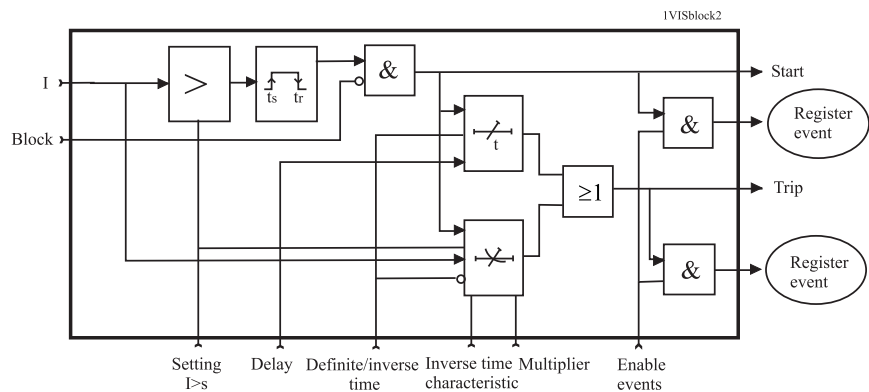

Figure 4.3: Block diagram of a basic protection function

5 Protection functions

Each protection stage can independently be enabled or disabled according to the requirements of the intended application.

5.1 Maximum number of protection stages in one application

The device limits the maximum number of enabled stages to about 30, depending of the type of the stages.

For more information, please see the configuration instructions in Chapter 2.4 Configuration and parameter setting.

5.2 General features of protection stages

Setting groups

Setting groups are controlled by using digital inputs, function keys or virtual inputs. When none of the assigned input/inputs is/are not active the active setting group is defined by parameter 'SetGrp no control state'. When controlled input activates the corresponding setting group is activated as well. If multiple inputs are active at the same time the active setting group is defined by 'SetGrp priority'. By using virtual I/O the active setting group can be controlled using the local panel display, any communication protocol or using the inbuilt programmable logic functions.

Set group 1 DI control	-			
Set group 2 DI control	-			
Set group 3 DI control	-			
Set group 4 DI control	-			
Group	1			
	Group 1	Group 2	Group 3	Group 4
Pick-up setting	480 A	480 A	480 A	480 A
Pick-up setting	1.20 xlmot	1.20 xlmot	1.20 xlmot	1.20 xlmot
Delay curve family	IEC	IEC	IEC	IEC
Delay type	III	III	III	III
Inv. time coefficient k	1.00	1.00	1.00	1.00
Inverse delay (20x)	2.26 s	2.26 s	2.26 s	2.26 s
Inverse delay (4x)	4.97 s	4.97 s	4.97 s	4.97 s
Inverse delay (1x)	600.02 s	600.02 s	600.02 s	600.02 s
Common settings				
Include harmonics	Off			

Example

Any digital input could be used to control setting groups but in this example DI1, DI2, DI3 and DI4 are chosen to control setting groups 1 to 4. This setting is done with a parameter "Set group x DI control" where x refers to the desired setting group.

Set group 1 DI control	DI1				
Set group 2 DI control	DI2				
Set group 3 DI control	DI3				
Set group 4 DI control	DI4				
Group	2				
	Group 1	Group 2	Group 3	Group 4	
Pick-up setting	1500 A	3600 A	3600 A	3600 A	
Pick-up setting	0.50 xIn	1.20 xIn	1.20 xIn	1.20 xIn	
Delay curve family	DT	IEC	IEC	IEC	
Delay type	DT	NI	NI	NI	
Operation delay	0.30 s	0.30 s	0.30 s	0.30 s	
Inv. time coefficient k	1.00	1.00	1.00	1.00	
Inverse delay (20x)	- s	2.26 s	2.26 s	2.26 s	
Inverse delay (4x)	- s	4.97 s	4.97 s	4.97 s	
Inverse delay (1x)	- s	600.02 s	600.02 s	600.02 s	

Figure 5.1: DI1, DI2, DI3, DI4 are configured to control Groups 1 to 4 respectively.

“SetGrp priority” is used to give a condition to a situation where two or more digital inputs, controlling setting groups, are active and at a same time . SetGrp priority could have vales “1 to 4” or “4 to 1”.

VALID PROTECTION STAGES	
Enabled stages	1
SetGrp common change	1
SetGrp no control state	1
SetGrp priority	1 to 4

Figure 5.2: SetGrp priority setting is located in the Valid Protection stages view.

Assuming that DI2 and DI3 are active at a same time and SetGrp priority is set to “1 to 4” setting group 2 will become active. In case SetGrp priority is reversed i.e. it is set to “4 to 1” setting group 3 would be active.

Forcing start or trip condition for testing

The status of a protection stage can be one of the followings:

- **Ok = ‘-‘**
The stage is idle and is measuring the analog quantity for the protection. No fault detected.
- **Blocked**
The stage is detecting a fault but blocked by some reason.
- **Start**
The stage is counting the operation delay.
- **Trip**
The stage has tripped and the fault is still on.

The blocking reason may be an active signal via the block matrix from other stages, the programmable logic or any digital input. Some stages also have inbuilt blocking logic. For more details about block matrix, see Chapter 8.5 Blocking matrix.

Forcing start or trip condition for testing purposes

There is a "Force flag" parameter which, when activated, allows forcing the status of any protection stage to be "start" or "trip" for a half second. By using this forcing feature any current or voltage injection to the device is not necessary to check the output matrix configuration, to check the wiring from the output relays to the circuit breaker and also to check that communication protocols are correctly transferring event information to a SCADA system.

After testing the force flag will automatically reset 5-minute after the last local panel push button activity.

The force flag also enables forcing of the output relays and forcing the optional mA outputs.

Force flag can be found in relays menu.

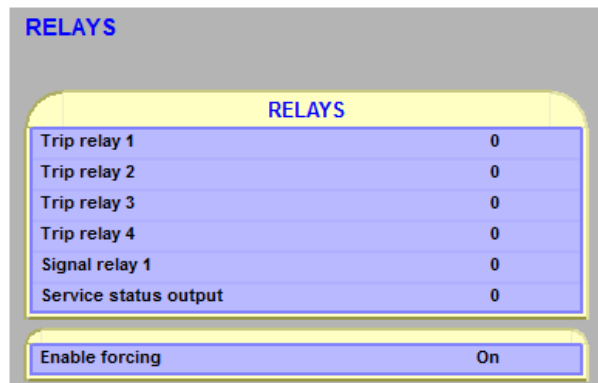

Start and trip signals

Every protection stage has two internal binary output signals: start and trip. The start signal is issued when a fault has been detected. The trip signal is issued after the configured operation delay unless the fault disappears before the end of the delay time.

Output matrix

Using the output matrix the user connects the internal start and trip signals to the output relays and indicators. For more details, see Chapter 8.4 Output matrix.

Blocking

Any protection function, except arc protection, can be blocked with internal and external signals using the block matrix (Chapter 8.5 Blocking matrix). Internal signals are for example logic outputs and start and trip signals from other stages and external signals are for example digital and virtual inputs.

Some protection stages have also inbuilt blocking functions. For example under-frequency protection has inbuilt under-voltage blocking to avoid tripping when the voltage is off.

When a protection stage is blocked, it won't pick-up in case of a fault condition is detected. If blocking is activated during the operation delay, the delay counting is frozen until the blocking goes off or the pick-up reason, i.e. the fault condition, disappears. If the stage is already tripping, the blocking has no effect.

Retardation time

Retardation time is the time a protection relay needs to notice, that a fault has been cleared during the operation time delay. This parameter is important when grading the operation time delay settings between relays.

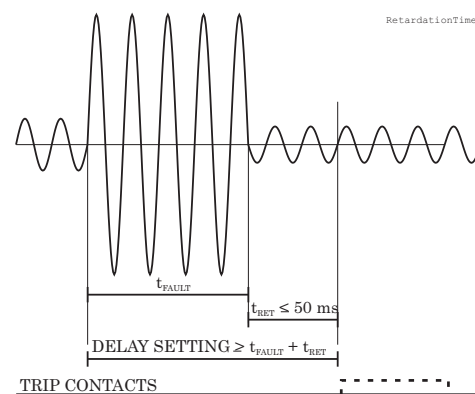

Figure 5.3: Definition for retardation time. If the delay setting would be slightly shorter, an unselective trip might occur (the dash line pulse).

For example when there is a big fault in an outgoing feeder, it might start i.e. pick-up both the incoming and outgoing feeder relay. However the fault must be cleared by the outgoing feeder relay and the incoming feeder relay must not trip. Although the operating delay setting of the incoming feeder is more than at the outgoing feeder, the incoming feeder might still trip, if the operation time difference is not big enough. The difference must be more than the retardation time of the incoming feeder relay plus the operating time of the outgoing feeder circuit breaker.

Figure 5.3 shows an overvoltage fault seen by the incoming feeder, when the outgoing feeder does clear the fault. If the operation delay setting would be slightly shorter or if the fault duration would be slightly longer than in the figure, an unselective trip might happen (the dashed 40 ms pulse in the figure). In VAMP devices the retardation time is less than 50 ms.

Reset time (release time)

Figure 5.4 shows an example of reset time i.e. release delay, when the relay is clearing an overcurrent fault. When the relay's trip contacts are closed the circuit breaker (CB) starts to open. After the CB contacts are open the fault current will still flow through an arc between the opened contacts. The current is finally cut off when the

arc extinguishes at the next zero crossing of the current. This is the start moment of the reset delay. After the reset delay the trip contacts and start contact are opened unless latching is configured. The precise reset time depends on the fault size; after a big fault the reset time is longer. The reset time also depends on the specific protection stage.

The maximum reset time for each stage is specified in Chapter 12.3 Protection functions. For most stages it is less than 95 ms.

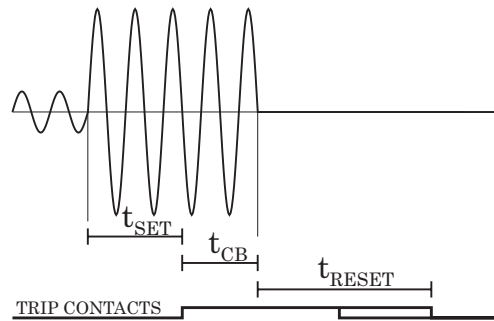

Figure 5.4: Reset time is the time it takes the trip or start relay contacts to open after the fault has been cleared.

Hysteresis or dead band

When comparing a measured value against a pick-up value, some amount of hysteresis is needed to avoid oscillation near equilibrium situation. With zero hysteresis any noise in the measured signal or any noise in the measurement itself would cause unwanted oscillation between fault-on and fault-off situations.

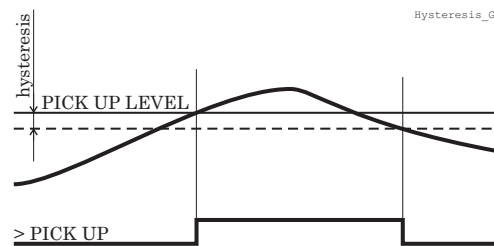

Figure 5.5: Behaviour of a greater than comparator. For example in overvoltage stages the hysteresis (dead band) acts according this figure.

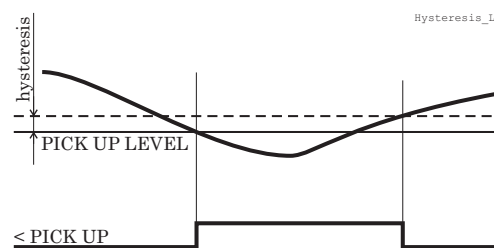

Figure 5.6: Behaviour of a less than comparator. For example in under-voltage and under frequency stages the hysteresis (dead band) acts according this figure.

5.3 Differential overcurrent protection $\Delta I >$ (87)

The differential overcurrent protection comprises two separately adjustable stages, stage $\Delta I >$ and stage $\Delta I >>$.

The differential protection is based on winding currents difference between I_L and I'_L side. In transformer applications the current calculation depends on transformer connection group. E.g. in $Yy0$ connection measured currents are also winding currents, see Figure 5.7. In generator applications the connection group is always $Yy0$ and measured currents are also winding currents.

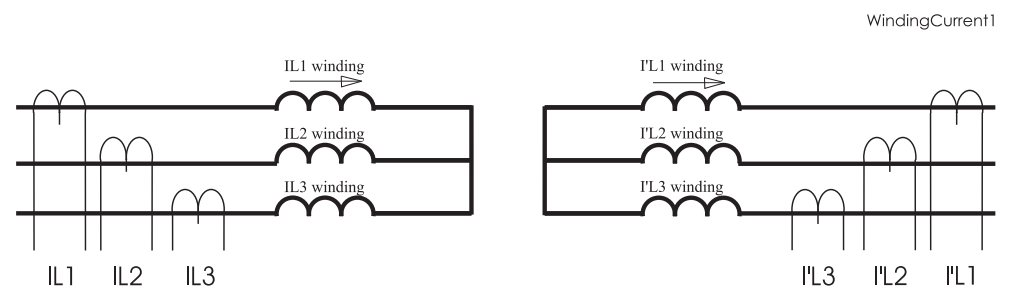

Figure 5.7: Winding currents in connection group $Yy0$.

In the second example if transformer I_L side is connected to open delta, e.g. $Dy11$, then winding currents are calculated in delta side (I_L side), see Figure 5.8.

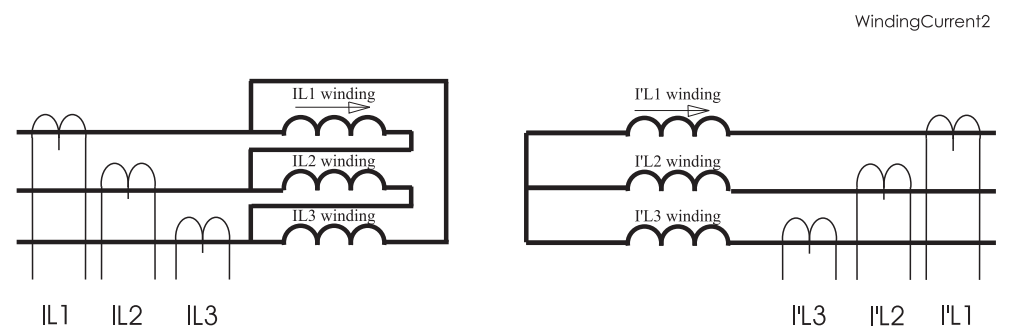

Figure 5.8: Winding currents in connection group $Dy11$.

Equation 5.1: Winding current calculation in delta side, Dy11 connection

$$\frac{\overline{I_{L1W}}}{\sqrt{3}} = \left(\overline{I_{L1}} - \overline{I_{L2}} \right)$$

$$\frac{\overline{I_{L2W}}}{\sqrt{3}} = \left(\overline{I_{L2}} - \overline{I_{L3}} \right)$$

$$\frac{\overline{I_{L3W}}}{\sqrt{3}} = \left(\overline{I_{L3}} - \overline{I_{L1}} \right)$$

Equation 5.2: Winding currents in star side, Dy11 connection

$$\overline{I'_{L1W}} = \overline{I'_{L1}}$$

$$\overline{I'_{L2W}} = \overline{I'_{L2}}$$

$$\overline{I'_{L3W}} = \overline{I'_{L3}}$$

Equation 5.3: Bias current

$$I_b = \frac{|\overline{I_W}| + |\overline{I'_{W}}|}{2}$$

Equation 5.4: Differential current

$$I_d = \left| \overline{I_W} + \overline{I'_{W}} \right|$$

Bias current calculation is only used in protection stage $\Delta I >$. Bias current describes the average current flow in transformer. Bias and differential currents are calculated individually for each phase.

If transformer is earthed, e.g. connection group Dyn11, then zero current must be compensated before differential and bias current calculation. Zero current compensation can be selected individually for IL and I'L side.

Table 5.1 describe connection group and zero current compensation for different connection groups. If protection area is only generator then connection group setting is always Yy0, see Table 5.2. Also the settings of Un and U'n are set to be the same, e.g. generator nominal voltage.

Table 5.1: Zero current compensation in transformer applications

Transformer	Relay setting		
	ConnGrp	Io cmps	I'o cmps
YNy0	Yy0	ON	OFF
YNyn0	Yy0	ON	ON
Yy0	Yy0	OFF	OFF
Yyn0	Yy0	OFF	ON
YNy6	Yy6	ON	OFF
YNyn6	Yy6	ON	ON
Yy6	Yy6	OFF	OFF
Yyn6	Yy6	OFF	ON
Yd1	Yd1	OFF	OFF
YNd1	Yd1	ON	OFF
Yd5	Yd5	OFF	OFF
YNd5	Yd5	ON	OFF
Yd7	Yd7	OFF	OFF
YNd7	Yd7	ON	OFF
Yd11	Yd11	OFF	OFF
YNd11	Yd11	ON	OFF
Dy1	Dy1	OFF	OFF
Dyn1	Dy1	OFF	ON
Dy5	Dy5	OFF	OFF
Dyn5	Dy5	OFF	ON
Dy7	Dy7	OFF	OFF
Dyn7	Dy7	OFF	ON
Dy11	Dy11	OFF	OFF
Dyn11	Dy11	OFF	ON

Table 5.2: Zero current compensation in generator applications

Generator only	Relay setting		
	ConnGrp	Io cmps	I'o cmps
None earthing	Yy0	OFF	OFF

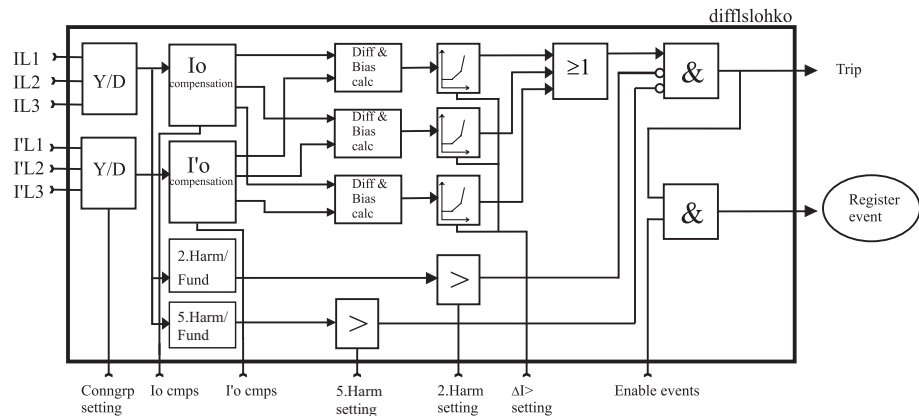

Figure 5.9: Block diagram of the differential overcurrent stage $\Delta I >$.

The stage $\Delta I >$ can be configured to operate as shown in Figure 5.10. This dual slope characteristic allows more differential current at higher currents before tripping.

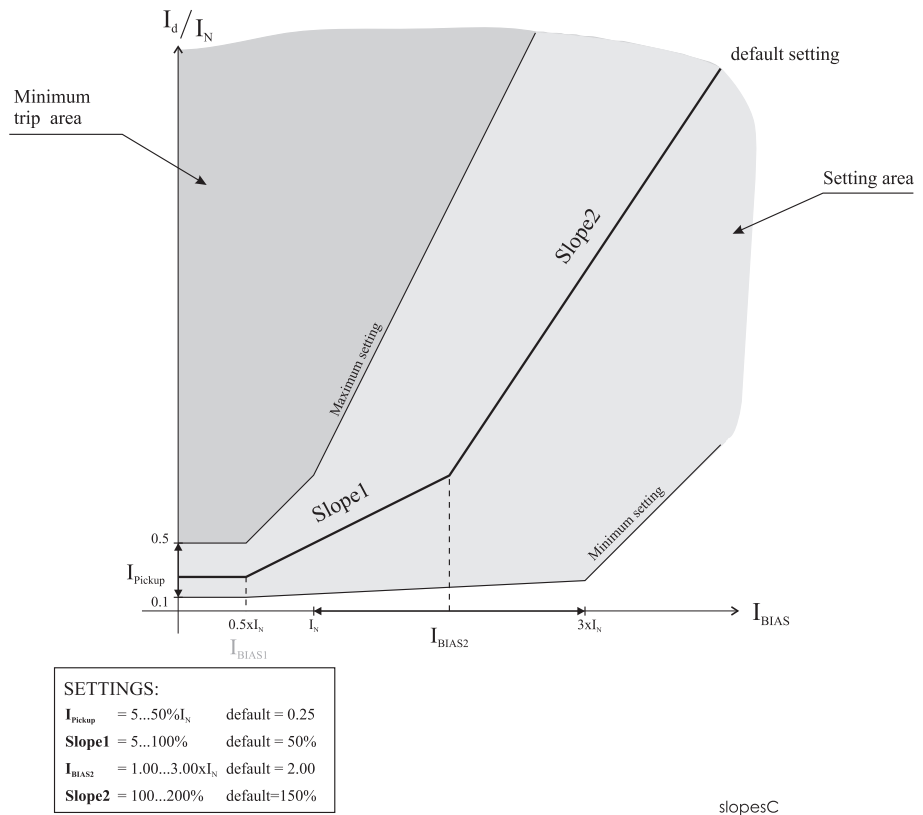

Figure 5.10: Example of differential overcurrent characteristics.

The stage also includes second harmonics blocking. The second harmonic is calculated from winding currents. Harmonic ratio is:

$$100 \times I_{f2_Winding} / I_{f1_Winding} [\%].$$

Fast differential overcurrent stage $\Delta I >>$ does not include slope characteristics and second harmonics blocking.

Table 5.3: Parameters of the differential overcurrent stages $\Delta I >$ (87)

	Parameter	Value/Unit	Description	
Measured values (1)	dIL1	xIn	Current difference value	
	dIL2			
	dIL3			
Setting values (2)	$\Delta I >$	%In	Setting value	
	Ibias1	xIn	Bias current start of slope 1	
	Slope1	%	Slope 1 setting	
	Ibias2	xIn	Bias current start of slope 2	
	Slope2	%	Slope 2 setting	
	Harm2>	On / Off	2. harmonic blocking enable/disable	
	Harm2>	%	2. harmonic block limit	
	TCntr		Cumulative trip counter	
	Type	1-N, 2-N, 3-N		Fault type/single-phase fault e.g.: 1 – N = fault on phase L1
		1-2, 2-3, 1-3		Fault type/two-phase fault e.g.: 2 – 3 = fault between L2 and L3
		1-2-3		Fault type/three-phase fault
	Flt	xIn	Max. value of fault differential current as compared to I_N	
	Bias	xIn	Value of bias current of faulted phase as compared to I_N	
Load	xIn	1 s mean value of pre-fault phase currents IL1 – IL3		

1) Measurement ranges are described in Table 12.1.

2) Setting ranges are described in Table 12.17.

Table 5.4: Parameters of the differential overcurrent stages $\Delta I >>$ (87)

	Parameter	Value/Unit	Description
Measured values	dIL1	xIn	Current difference value
	dIL2		
	dIL3		
Setting values	$\Delta I >>$	xIn	Setting value
Recorded values	TCntr		Cumulative trip counter
Recorded values	Type	1-N, 2-N, 3-N	Fault type/single-phase fault e.g.: 1-N = fault on phase L1
		1-2, 2-3, 1-3	Fault type/two-phase fault e.g.: 2-3 = fault between L2 and L3
		1-2-3	Fault type/three-phase fault
	Flt	xIn	Max. value of fault differential current as compared to I_N
	Load	xIn	1 s mean value of pre-fault phase currents IL1 – IL3

1) Measurement ranges are described in Table 12.1.

2) Setting ranges are described in Table 12.18.

5.4 Overcurrent protection I> (50/51)

Overcurrent protection is used against short circuit faults and heavy overloads.

The overcurrent function measures the fundamental frequency component of the phase currents. The protection is sensitive for the highest of the three phase currents. Whenever this value exceeds the user's pick-up setting of a particular stage, this stage picks up and a start signal is issued. If the fault situation remains on longer than the user's operation delay setting, a trip signal is issued.

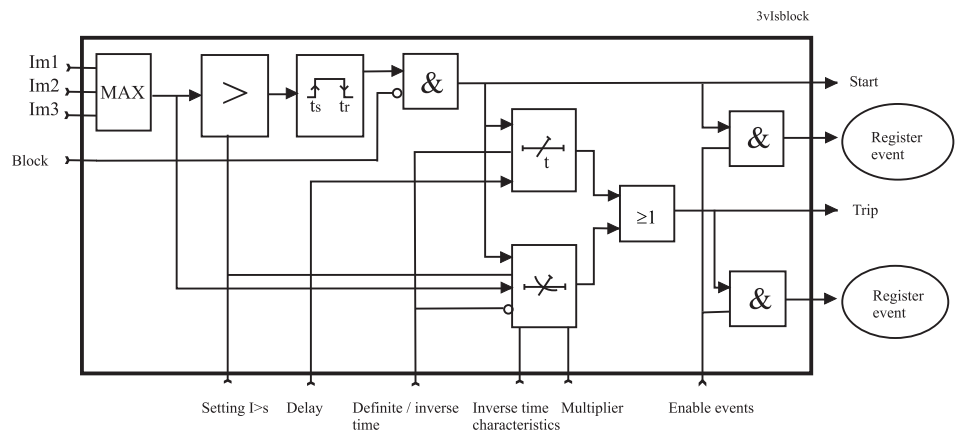

Figure 5.11: Block diagram of the three-phase overcurrent stage I> and I'>

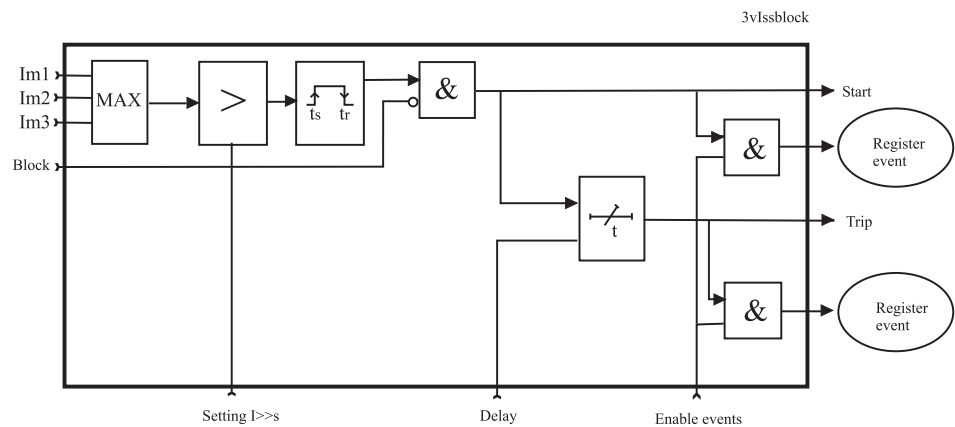

Figure 5.12: Block diagram of the three-phase overcurrent stage I>> and I'>>

Two independent stages

There are two separately adjustable overcurrent stages: I>, I>>, I'> and I'>>. The first stage I> can be configured for definite time (DT) or inverse time operation characteristic (IDMT). The stage I>> has definite time operation characteristic. By using the definite delay type and setting the delay to its minimum, an instantaneous (ANSI 50) operation is obtained.

Figure 5.11 shows a functional block diagram of the I> overcurrent stage with definite time and inverse time operation time. Figure 5.12 shows a functional block diagram of the I>> overcurrent stage with definite time operation delay.

Inverse operation time

Inverse delay means that the operation time depends on the amount the measured current exceeds the pick-up setting. The bigger the fault current is the faster will be the operation. Accomplished inverse delays are available for the I> stage. The inverse delay types are described in Chapter 5.13 Inverse time operation. The device will show the currently used inverse delay curve graph on the local panel display.

Inverse time limitation

The maximum measured secondary current is $50 \times I_N$. This limits the scope of inverse curves with high pick-up settings. See Chapter 5.13 Inverse time operation for more information.

Setting groups

There are four settings groups available for each stage. Switching between setting groups can be controlled by digital inputs, virtual inputs (communication, logic) and manually. See Chapter 5.2 General features of protection stages for more details.

Table 5.5: Parameters of the overcurrent stage I> and I'> (50/51)

Parameter	Value	Unit	Description	Note
Status	- Blocked Start Trip		Current status of the stage	 F F
TripTime		s	Estimated time to trip	
SCntr			Cumulative start counter	C
TCntr			Cumulative trip counter	C
SetGrp	1, 2, 3, 4		Active setting group	Set
SGrpDI			Digital signal to select the active setting group	Set
	-		None	
	Dlx		Digital input	
	Vlx		Virtual input	
	LEDx		LED indicator signal	
Force	Off		Force flag for status forcing for test purposes. This is a common flag for all stages and output relays, too. This flag is automatically reset 5 minutes after the last front panel push button pressing.	Set
	On			
ILmax		A	The supervised value. Max. of IL1, IL2 and IL3	
Status			Current status of the stage	

Parameter	Value	Unit	Description	Note
I>		A	Pick-up value scaled to primary value	
I>		xI_N	Pick-up setting	Set
Curve	DT IEC, IEEE, IEEE2, RI, PrgN		Delay curve family: Definite time Inverse time. See Chapter 5.13 Inverse time operation.	Set
Type	DT NI, VI, EI, LTI, Parameters		Delay type Definite time Inverse time. See Chapter 5.13 Inverse time operation.	Set
t>		s	Definite operation time (for definite time only)	Set
k>			Inverse delay multiplier (for inverse time only)	Set
Dly20x		s	Delay at 20xIset	
Dly4x		s	Delay at 4xIset	
Dly2x		s	Delay at 2xIset	
Dly1x		s	Delay at 1xIset	
IncHarm		On/off	Include Harmonics (Not in I'>stage)	
Delay curves			Graphic delay curve picture (only local display)	
A, B, C, D, E			User's constants for standard equations. Type=Parameters. Chapter 5.13 Inverse time operation.	Set
Recorded values	LOG1		Date and time of trip	
	Type		Fault type	
	Flt	xI_N	Fault current	
	Load	xI_N	Pre-fault current	
	Edly	%	Elapsed delay time	
	SetGrp		Active set group during fault	

Set = An editable parameter (password needed). C = Can be cleared to zero. F = Editable when force flag is on.

For details of setting ranges, see Table 12.19.

Table 5.6: Parameters of the overcurrent stages I>, I'>> (50/51)

Parameter	Value	Unit	Description	Note
Status	-		Current status of the stage	
	Blocked			
	Start			F
	Trip			F
SCntr			Cumulative start counter	C
TCntr			Cumulative trip counter	C
SetGrp	1, 2, 3, 4		Active setting group	Set

Parameter	Value	Unit	Description	Note
SGrpDI			Digital signal to select the active setting group	Set
	-		None	
	Dlx		Digital input	
	Vlx		Virtual input	
	LEDx		LED indicator signal	
	VOx		Virtual output	
Force	Off		Force flag for status forcing for test purposes. This is a common flag for all stages and output relays, too. Automatically reset by a 5-minute timeout.	Set
	On			
ILmax		A	The supervised value. Max. of IL1, IL2 and IL3	
I>>, I>>>		A	Pick-up value scaled to primary value	
I>>, I>>>		xI_N	Pick-up setting	Set
t>>, t>>>		s	Definite operation time.	Set
IncHarm		On/off	Include Harmonics	Set

Set = An editable parameter (password needed). C = Can be cleared to zero. F = Editable when force flag is on.

For details of setting ranges, see Table 12.20.

Recorded values of the latest eight faults

There is detailed information available of the eight latest faults: Time stamp, fault type, fault current, load current before the fault, elapsed delay and setting group.

Table 5.7: Recorded values of the overcurrent stages (8 latest faults) I>, I>>, I>>> (50/51)

Parameter	Value	Unit	Description
	yyyy-mm-dd		Time stamp of the recording, date
	hh:mm:ss.ms		Time stamp, time of day
Type			Fault type
	1-N		Ground fault
	2-N		Ground fault
	3-N		Ground fault
	1-2		Two phase fault
	2-3		Two phase fault
	3-1		Two phase fault
	1-2-3		Three phase fault
Flt		xI_N	Maximum fault current
Load		xI_N	1 s average phase currents before the fault
EDly		%	Elapsed time of the operating time setting. 100% = trip
SetGrp	1, 2, 3, 4		Active setting group during fault

5.4.1 Remote controlled overcurrent scaling

Pick-up setting of the three over current stages can also be controlled remotely. In this case only two scaling coefficients are possible: 100% (the scaling is inactive) and any configured value between 10% - 200% (the scaling is active). When scaling is enabled all settings of group one are copied to group two but the pick-up value of group two is changed according the given value (10-200%).

- This feature can be enabled/disabled via VAMPSET or by using the local panel. When using VAMPSET the scaling can be activated and adjusted in the “protection stage status 2” –menu. When using the local panel similar settings can be found from the “prot” -menu.
- It is also possible to change the scaling factor remotely by using the modbus TCP –protocol. When changing the scaling factor remotely value of 1% is equal to 1. Check the correct modbus address for this application from the VAMPSET or from the communication parameter list.

The screenshot shows a menu titled "Group 2 o/c remote scaling" with an "Enable" checkbox checked and a value of "150 %". Below it is a table for "Set group DI control" with "Group" set to 2. The table compares settings for Group 1 and Group 2. Red arrows indicate that the 150% scaling factor is applied to the pick-up settings of Group 2.

	Group 1	Group 2
Pick-up setting	1000 A	1500 A
Pick-up setting	1.00 xIn	1.50 xIn
Delay curve family	IEC	IEC
Delay type	III	III
Inv. time coefficient k	0.20	0.20
Inverse delay (20x)	0.45 s	0.45 s
Inverse delay (4x)	0.99 s	0.99 s
Inverse delay (1x)	141.83 s	141.15 s
Common settings		
Include harmonics	Off	

Figure 5.13: Remote scaling example.

In the Figure 5.13 can be seen the affect of remote scaling. After enabling group is changed from group one to group two and all settings from group one are copied to group two. The difference is that group two uses scaled pick-up settings.

NOTE: When remote scaling function is used, it replaces all the settings of group 2. So this function cannot be used simultaneously with normal group change.

5.5 Current unbalance protection $I_2>, I_2'>$ (46)

Current unbalance in a motor causes double frequency currents in the rotor. This warms up the surface of the rotor and the available thermal capacity of the rotor is much less than the thermal capacity of the whole motor. Thus an rms current based overload protection (see Chapter 5.7 Thermal overload protection $T>$ (49)) is not capable to protect a motor against current unbalance.

The current unbalance stage protects against unbalanced phase currents and single phasing. The protection is based on the negative sequence current. Both definite time and inverse time characteristics are available. The inverse delay is based on Equation 5.5. Only the base frequency components of the phase currents are used to calculate the negative sequence value I_2 .

The current unbalance protection is based on the negative sequence of the base frequency phase currents. Both definite time and inverse time characteristics are available.

Inverse delay

The inverse delay is based on the following equation.

Equation 5.5:

$$t = \frac{K_1}{\left(\frac{I_2}{I_N}\right)^2 - K_2^2}$$

$T =$ Operation time

$K_1 =$ Delay multiplier

$I_2 =$ Measured and calculated negative sequence phase current of fundamental frequency.

$I_N =$ Rated current of the transformer

$K_2 =$ Pick-up setting $I_2>$ in pu. The maximum allowed degree of unbalance.

Example:

$K_1 =$ 15 s

$I_2 =$ 22.9 % = 0.229 x I_N

$K_2 =$ 5 % = 0.05 x I_N

$$t = \frac{15}{\left(\frac{0.229}{1}\right)^2 - 0.05^2} = 300.4$$

The operation time in this example will be five minutes.

More stages (definite time delay only)

If more than one definite time delay stages are needed for current unbalance protection, the freely programmable stages can be used (Chapter 5.11 Programmable stages (99)).

Setting groups

There are four settings groups available. Switching between setting groups can be controlled by digital inputs, virtual inputs (communication, logic) and manually. See Chapter 5.2 General features of protection stages for more details.

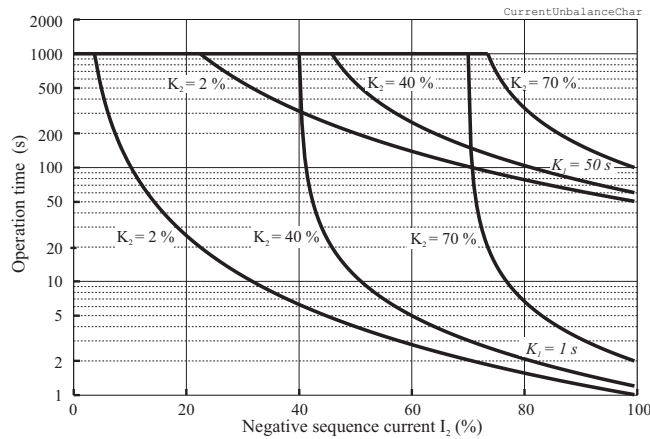

Figure 5.14: Inverse operation delay of current unbalance stage $I_2>$. The longest delay is limited to 1000 seconds (=16min 40s).

Table 5.8: Parameters of the current unbalance stage $I_2>$, $I_2'>$ (46)

Parameter	Value	Unit	Description	Note
Status	-		Current status of the stage	
	Blocked			
	Start			F
	Trip			F
SCntr			Cumulative start counter	C
TCntr			Cumulative trip counter	C
SetGrp	1, 2, 3, 4		Active setting group	Set
SGrpDI			Digital signal to select the active setting group	Set
	-		None	
	Dlx		Digital input	
	Vlx		Virtual input	
	LEDx		LED indicator signal	
	VOx		Virtual output	
Force	Off		Force flag for status forcing for test purposes. This is a common flag for all stages and output relays, too. Automatically reset by a 5-minute timeout.	Set
	On			
I2/In		% In		

Parameter	Value	Unit	Description	Note
$I_2 >$		% In	Pick-up setting	Set
$t >$		s	Definite operation time (Type=DT)	Set
Type	DT INV		Definite time Inverse time (Equation 5.5)	Set
K1		s	Delay multiplier (Type =INV)	Set

Set = An editable parameter (password needed). C = Can be cleared to zero. F = Editable when force flag is on.

For details of setting ranges, see Table 12.22.

Recorded values of the latest eight faults

There is detailed information available of the eight latest faults: Time stamp, unbalance current, elapsed delay and setting group.

Table 5.9: Recorded values of the current unbalance stage (8 latest faults) $I_2 >$, $I_2' >$ (46)

Parameter	Value	Unit	Description
	yyyy-mm-dd		Time stamp of the recording, date
	hh:mm:ss.ms		Time stamp, time of day
Flt		% In	Maximum unbalance current
EDly		%	Elapsed time of the operating time setting. 100% = trip
SetGrp	1, 2, 3, 4		Active setting group during the fault

5.6 Earth fault protection $I_0 >$ (50N/51N)

The unidirectional earth fault protection is to detect earth faults in low impedance earthed networks. In high impedance earthed networks, compensated networks and isolated networks unidirectional earth fault can be used as back-up protection.

The unidirectional earth fault function is sensitive to the fundamental frequency component of the residual current $3I_0$. The attenuation of the third harmonic is more than 60 dB. Whenever this fundamental value exceeds the user's pick-up setting of a particular stage, this stage picks up and a start signal is issued. If the fault situation remains on longer than the user's operation time delay setting, a trip signal is issued.

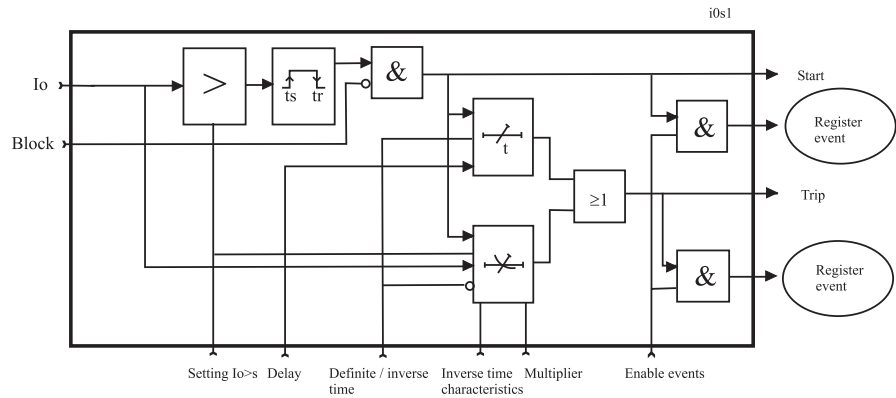

Figure 5.15: Block diagram of the earth fault stage $I_0 >$

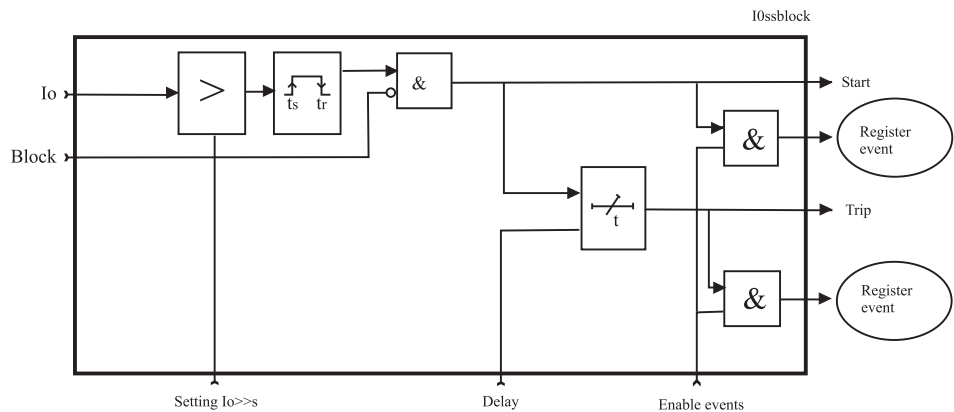

Figure 5.16: Block diagram of the earth fault stages $I_0 >>$, $I_0 >>>$, $I_0 >>>>$

Figure 5.15 shows a functional block diagram of the $I_0 >$ earth overcurrent stage with definite time and inverse time operation time. Figure 5.16 shows a functional block diagram of the $I_0 >>$, $I_0 >>>$ and $I_0 >>>>$ earth fault stages with definite time operation delay.

Input signal selection

Each stage can be connected to supervise any of the following inputs and signals:

- Input I_{01} for all networks other than rigidly earthed.
- Input I_{02} for all networks other than rigidly earthed.
- Calculated signal I_{0Calc} for rigidly and low impedance earthed networks. $I_{0Calc} = I_{L1} + I_{L2} + I_{L3}$.
- Calculated signal I'_{0Calc} for rigidly and low impedance earthed networks. $I'_{0Calc} = I'_{L1} + I'_{L2} + I'_{L3}$.

Intermittent earth fault detection

Short earth faults make the protection to start (to pick up), but will not cause a trip. (Here a short fault means one cycle or more. For

shorter than 1 ms transient type of intermittent earth faults in compensated networks there is a dedicated stage $I_{0INT} > 67N$.) When starting happens often enough, such intermittent faults can be cleared using the intermittent time setting.

When a new start happens within the set intermittent time, the operation delay counter is not cleared between adjacent faults and finally the stage will trip.

Four independent unidirectional earth fault overcurrent stages

There are four separately adjustable earth fault stages: $I_0 >$, $I_0 >>$, $I_0 >>>$, and $I_0 >>>>$. The first stage $I_0 >$ can be configured for definite time (DT) or inverse time operation characteristic (IDMT). The other stages have definite time operation characteristic. By using the definite delay type and setting the delay to its minimum, an instantaneous (ANSI 50N) operation is obtained.

Inverse operation time ($I_0 >$ stage only)

Inverse delay means that the operation time depends on the amount the measured current exceeds the pick-up setting. The bigger the fault current is the faster will be the operation. Accomplished inverse delays are available for the $I_0 >$ stage. The inverse delay types are described in Chapter 5.13 Inverse time operation. The device will show a scaleable graph of the configured delay on the local panel display.

Inverse time limitation

The maximum measured secondary residual current is $10 \times I_{0N}$ and maximum measured phase current is $50 \times I_N$. This limits the scope of inverse curves with high pick-up settings. See Chapter 5.13 Inverse time operation for more information.

Setting groups

There are four settings groups available for each stage. Switching between setting groups can be controlled by digital inputs, virtual inputs (communication, logic) and manually. See Chapter 5.2 General features of protection stages for more details.

Table 5.10: Parameters of the unidirectional earth fault stage $I_0 >$ (50N/51N)

Parameter	Value	Unit	Description	Note
Status	- Blocked Start Trip		Current status of the stage	 F F
TripTime		s	Estimated time to trip	
SCntr			Cumulative start counter	Clr
TCntr			Cumulative trip counter	Clr

Parameter	Value	Unit	Description	Note
SetGrp	1, 2, 3, 4		Active setting group	Set
SGrpDI			Digital signal to select the active setting group	Set
	-		None	
	Dlx		Digital input	
	Vlx		Virtual input	
	LEDx		LED indicator signal	
Force	Off		Force flag for status forcing for test purposes. This is a common flag for all stages and output relays, too. Automatically reset by a 5-minute timeout.	Set
	On			
Io1, Io2, IoCalc, I'oCalc, Io1Peak, Io2Peak		pu	The supervised value according the parameter "Input" below.	
Io>		A	Pick-up value scaled to primary value	
Io>		pu	Pick-up setting relative to the parameter "Input" and the corresponding CT value	Set
Curve	DT		Delay curve family: Definite time	Set
	IEC, IEEE, IEEE2, RI, PrgN		Inverse time. Chapter 5.13 Inverse time operation.	
Type	DT		Delay type. Definite time	Set
	NI, VI, EI, LTI, Parameters		Inverse time. Chapter 5.13 Inverse time operation.	
t>		s	Definite operation time (for definite time only)	Set
k>			Inverse delay multiplier (for inverse time only)	Set
Input	Io1		X1:7 – 8. See Chapter 11 Connections.	Set
	Io2		X1:9 – 10	
	IoCalc		IL1 + IL2 + IL3	
	I'oCalc		I'L1 + I'L2 + I'L3	
	Io1Peak		X1:7 – 8 peak mode ($I_{0\phi>}$ only)	
	Io2Peak		X1:9 – 10 peak mode ($I_{0\phi>}$ only)	
Intrmt		s	Intermittent time	Set
Dly20x		s	Delay at 20xIset	
Dly4x		s	Delay at 4xIset	
Dly2x		s	Delay at 2xIset	
Dly1x			Delay at 1xIset	
A, B, C, D, E			User's constants for standard equations. Type=Parameters. See Chapter 5.13 Inverse time operation.	Set

Set = An editable parameter (password needed). C = Can be cleared to zero. F = Editable when force flag is on.

For details of setting ranges, see Table 12.23.

Table 5.11: Parameters of the unidirectional earth fault stage $I_0 >>$, $I_0 >>>$, $I_0 >>>>$ (50N/51N)

Parameter	Value	Unit	Description	Note
Status	- Blocked Start Trip		Current status of the stage	F F
TripTime		s	Estimated time to trip	
SCntr			Cumulative start counter	Clr
TCntr			Cumulative trip counter	Clr
SetGrp	1, 2, 3, 4		Active setting group	Set
SgrpDI	- Dix Vix LEDx VOx		Digital signal to select the active setting group None Digital input Virtual input LED indicator signal Virtual output	Set
Force	Off On		Force flag for status forcing for test purposes. This is a common flag for all stages and output relays, too. Automatically reset by a 5-minute timeout.	Set
Io1 Io2 IoCalc		pu	The supervised value according the parameter "Input" below.	
$I_0 >>$, $I_0 >>>$, $I_0 >>>>$		A	Pick-up value scaled to primary value	
$I_0 >>$, $I_0 >>>$, $I_0 >>>>$		pu	Pick-up setting relative to the parameter "Input" and the corresponding CT value	Set
$t >$		s	Definite operation time (for definite time only)	Set
Input	Io1 Io2 IoCalc I'oCalc		X1:7 – 8. See Chapter 11 Connections. X1:9 – 10 IL1 + IL2 + IL3 I'L1 + I'L2 + I'L3	Set

Set = An editable parameter (password needed). C = Can be cleared to zero. F = Editable when force flag is on.

For details of setting ranges, see Table 12.24.

Recorded values of the latest eight faults

There is detailed information available of the eight latest earth faults: Time stamp, fault current, elapsed delay and setting group.

Table 5.12: Recorded values of the unidirectional earth fault stages (8 latest faults) $I_0>>$, $I_0>>>$, $I_0>>>>$ (50N/51N)

Parameter	Value	Unit	Description
	yyyy-mm-dd		Time stamp of the recording, date
	hh:mm:ss.ms		Time stamp, time of day
Flt		pu	Maximum earth fault current
EDly		%	Elapsed time of the operating time setting. 100% = trip
SetGrp	1, 2, 3, 4		Active setting group during fault

5.6.1 Earth fault faulty phase detection algorithm

Phase recognition:

A zero sequence overcurrent has been detected.

Faulted phase/ phases are detected in 2 stage system.

1. Algorithm is using delta principle to detect the faulty phase/ phases.
2. Algorithm confirms the faulty phase with neutral current angle comparison to the suspected faulted phase.

Ideal grounded network:

When there is forward earth fault in phase L1, its current will increase creating calculated or measured zero sequence current in phase angle of 0 degrees. If there is reverse earth fault in phase L1, its current will decrease creating calculated or measured zero sequence current in phase angle of 180 degrees.

When there is forward earth fault in phase L2, its current will increase creating calculated or measured zero sequence current in phase angle of -120 degrees. If there is reverse earth fault in phase L2, its current will decrease creating calculated or measured zero sequence current in phase angle of 60 degrees.

When there is forward earth fault in phase L3, its current will increase creating calculated or measured zero sequence current in phase angle of 120 degrees. If there is reverse earth fault in phase L3 its current will decrease creating calculated or measured zero sequence current in phase angle of -60 degrees.

Implementation:

When faulty phase is recognized, it will be recorded in 50N protection fault log (also in event list and alarm screen). This faulted phase and direction recording function has a tick box for enabling/disabling in protection stage settings. For compensated network, this is not a 100% reliable algorithm because it depends on the network compensation degree. So for compensated networks this feature can be turned off so it will not cause confusion. For high impedance

earthed networks, there will be drop down menu in both setting groups to choose between RES/CAP. RES is default and it is for earthed networks. When CAP is chosen, the I_0 angle will be corrected to inductive direction 90 degrees and after that faulty phase detection is made.

Possible outcomes and conditions for those detections:

- FWD L1
Phase L1 increases above the set limit and two other phases remain inside the set (delta) limit. I_0 current angle is +/- 60 degrees from L1 phase angle.
- FWD L2
Phase L2 increases above the set limit and two other phases remain inside the set (delta) limit. I_0 current angle is +/- 60 degrees from L2 phase angle.
- FWD L3
Phase L3 increases above the set limit and two other phases remain inside the set (delta) limit. I_0 current angle is +/- 60 degrees from L3 phase angle.
- FWD L1-L2
Phase L1 and L2 increase above the set limit and phase L3 remains inside the set (delta) limit. I_0 current angle is between L1 and L2 phase angles.
- FWD L2-L3
Phase L2 and L3 increase above the set limit and phase L1 remains inside the set (delta) limit. I_0 current angle is between L2 and L3 phase angles.
- FWD L3-L1
Phase L3 and L1 increase above the set limit and phase L2 remains inside the set (delta) limit. I_0 current angle is between L3 and L3 phase angles.
- FWD L1-L2-L3
All three phase currents increase above the set delta limit.
- REV 1 (any one phase)
One phase decreases below the set delta limit and other two phases remain inside the delta limit.
- REV 2 (any two phase)
Two phases decrease below the set delta limit and third phase remains inside the delta limit.
- REV 3 (all three phases)
All three phase currents decrease below the set delta limit.

Below are simulated different fault scenarios:

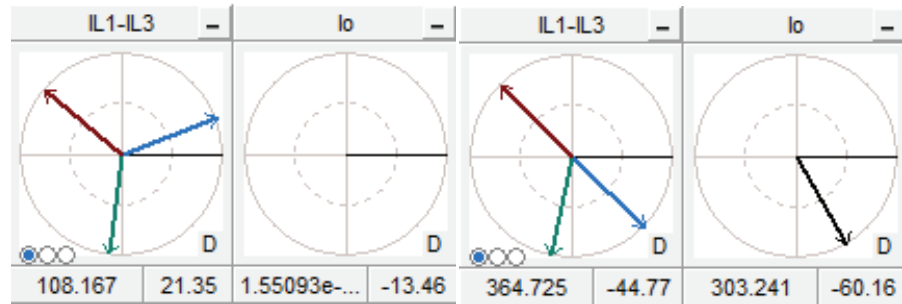

Figure 5.17: Phase L1 forward

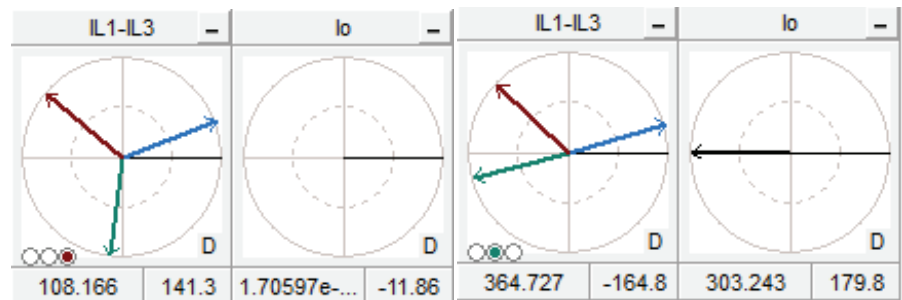

Figure 5.18: Phase L2 forward

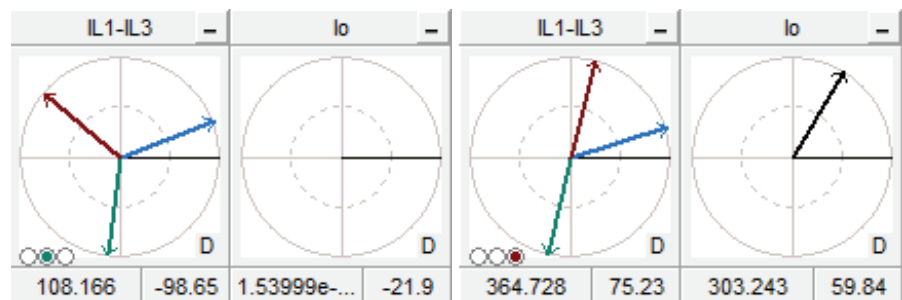

Figure 5.19: Phase L3 forward

5.7 Thermal overload protection T> (49)

The thermal overload function protects the transformer against excessive temperatures.

Thermal model

The temperature is calculated using rms values of phase currents and a thermal model according IEC 60255-8. The rms values are calculated using harmonic components up to the 15th.

$$\text{Trip time: } t = \tau \cdot \ln \frac{I^2 - I_P^2}{I^2 - a^2}, \quad \tau \text{ unit: second}$$

$$\text{Alarm: } a = k \cdot k_{\Theta} \cdot I_N \cdot \sqrt{\text{alarm}} \quad (\text{Alarm 60\%} = 0.6)$$

$$\text{Trip: } a = k \cdot k_{\Theta} \cdot I_N$$

$$\text{Release time: } t = \tau \cdot C_{\tau} \cdot \ln \frac{I_P^2}{a^2 - I^2}, \quad \tau \text{ unit: second}$$

$$\text{Trip release: } a = \sqrt{0.95} \times k \times I_N$$

$$\text{Start release: } a = \sqrt{0.95} \times k \times I_N \times \sqrt{\text{alarm}} \quad (\text{Alarm 60\%} = 0.6)$$

T = Operation time

τ = Thermal time constant tau (Setting value)

ln = Natural logarithm function

I = Measured rms phase current (the max. value of three phase currents)

I_p = Preload current, $I_P = \sqrt{\theta} \times k \times I_N$ (If temperature rise is 120% ($\theta = 1.2$). This parameter is the memory of the algorithm and corresponds to the actual temperature rise.

k = Overload factor (Maximum continuous current), i.e. service factor.(Setting value)

k Θ = Ambient temperature factor (Permitted current due to t_{amb}).

I_N = The rated current

C _{τ} = Relay cooling time constant (Setting value)

Time constant for cooling situation

If the transformer's fan is stopped, the cooling will be slower than with an active fan. Therefore there is a coefficient C_T for thermal constant available to be used as cooling time constant, when current is less than $0.3 \times I_N$.

Heat capacitance, service factor and ambient temperature

The trip level is determined by the maximum allowed continuous current I_{MAX} corresponding to the 100 % temperature rise Θ_{TRIP} i.e. the heat capacitance of the transformer. I_{MAX} depends of the given service factor k and ambient temperature Θ_{AMB} and settings I_{MAX40} and I_{MAX70} according the following equation.

$$I_{MAX} = k \cdot k_{\Theta} \cdot I_N$$

The value of ambient temperature compensation factor k_{Θ} depends on the ambient temperature Θ_{AMB} and settings I_{MAX40} and I_{MAX70} . See Figure 5.20. Ambient temperature is not in use when $k_{\Theta} = 1$. This is true when

- I_{MAX40} is 1.0
- S_{amb} is "n/a" (no ambient temperature sensor)
- T_{AMB} is +40 °C.

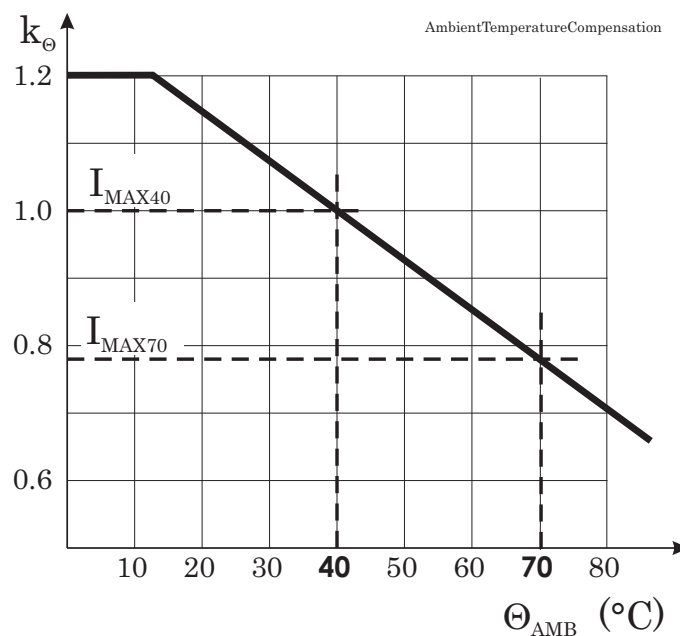

Figure 5.20: Ambient temperature correction of the overload stage T>.

Example of a behaviour of the thermal model

Figure 5.20 shows an example of the thermal model behaviour. In this example $\tau = 30$ minutes, $k = 1.06$ and $k\Theta = 1$ and the current has been zero for a long time and thus the initial temperature rise is 0 %. At time = 50 minutes the current changes to $0.85 \times I_N$ and the temperature rise starts to approach value $(0.85/1.06)^2 = 64$ % according the time constant. At time = 300 min, the temperature is about stable, and the current increases to 5 % over the maximum defined by the rated current and the service factor k . The temperature rise starts to approach value 110 %. At about 340 minutes the temperature rise is 100 % and a trip follows.

Initial temperature rise after restart

When the device is switched on, an initial temperature rise of 70 % is used. Depending of the actual current, the calculated temperature rise then starts to approach the final value.

Alarm function

The thermal overload stage is provided with a separately settable alarm function. When the alarm limit is reached the stage activates its start signal.

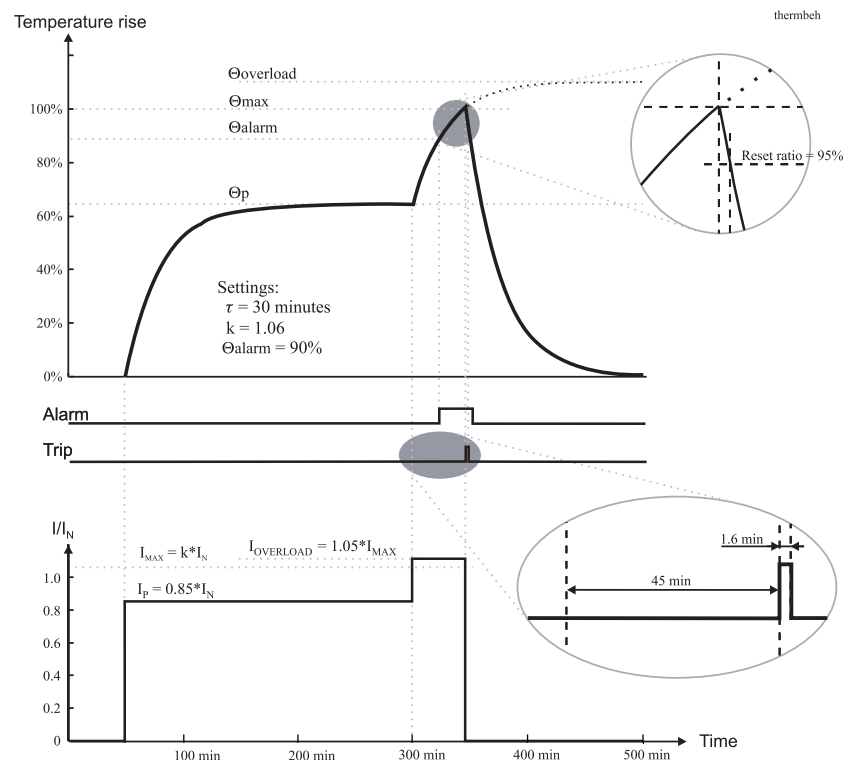

Figure 5.21: Example of the thermal model behaviour.

Table 5.13: Parameters of the thermal overload stage T> (49)

Parameter	Value	Unit	Description	Note
Status	- Blocked Start Trip		Current status of the stage	 F F
Time	hh:mm:ss		Estimated time to trip	
SCntr			Cumulative start counter	C
TCntr			Cumulative trip counter	C
Force	Off On		Force flag for status forcing for test purposes. This is a common flag for all stages and output relays, too. Automatically reset by a 5-minute timeout.	Set
T		%	Calculated temperature rise. Trip limit is 100 %.	F
MaxRMS		Arms	Measured current. Highest of the three phases.	
I _{max}		A	$k \times I_N$. Current corresponding to the 100 % temperature rise.	
k>		$\times I_N$	Allowed overload (service factor)	Set
Alarm		%	Alarm level	Set
tau		min	Thermal time constant	Set
ctau		xtau	Coefficient for cooling time constant. Default = 1.0	Set
kTamb		$\times I_N$	Ambient temperature corrected max. allowed continuous current	
I _{max40}		$\% I_N$	Allowed load at Tamb +40 °C. Default = 100 %.	Set
I _{max70}		$\% I_N$	Allowed load at Tamb +70 °C.	Set
Tamb		°C	Ambient temperature. Editable Samb=n/a. Default = +40 °C	Set
Samb			Sensor for ambient temperature	Set
	n/a		No sensor in use for Tamb	
	ExtAI1 – 16		External Analogue input 1 – 16	

Set = An editable parameter (password needed). C = Can be cleared to zero. F = Editable when force flag is on.

For details of setting ranges, see Table 12.21.

5.8 Magnetising inrush $I_{f2} > (68F2)$

This stage is mainly used to block other stages. The ratio between the second harmonic component and the fundamental frequency component is measured on all the phase currents. When the ratio in any phase exceeds the setting value, the stage gives a start signal. After a settable delay, the stage gives a trip signal.

The start and trip signals can be used for blocking the other stages.

The trip delay is irrelevant if only the start signal is used for blocking.

The trip delay of the stages to be blocked must be more than 60 ms to ensure a proper blocking.

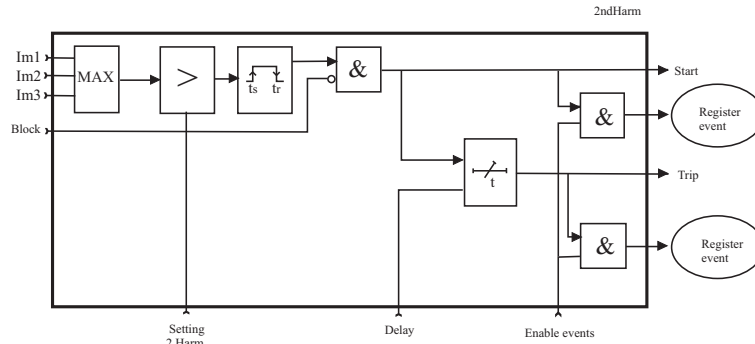

Figure 5.22: Block diagram of the magnetising inrush stage.

Table 5.14: Setting parameters of magnetising inrush blocking (68F2)

Parameter	Value	Unit	Default	Description
If2>	10 – 100	%	10	Setting value If2/Ifund
t_f2	0.05 – 300.0	s	0.05	Definite operating time
S_On	Enabled; Disabled	-	Enabled	Start on event
S_Off	Enabled; Disabled	-	Enabled	Start off event
T_On	Enabled; Disabled	-	Enabled	Trip on event
T_Off	Enabled; Disabled	-	Enabled	Trip off event

For details of setting ranges, see Table 12.26.

Table 5.15: Measured and recorded values of magnetising inrush blocking (68F2)

	Parameter	Value	Unit	Description
Measured values	IL1H2.		%	2. harmonic of IL1, proportional to the fundamental value of IL1
	IL2H2.		%	2. harmonic of IL2
	IL3H2.		%	2. harmonic of IL3
Recorded values	Flt		%	The max. fault value
	EDly		%	Elapsed time as compared to the set operating time; 100% = tripping

5.9 Transformer over excitation $I_{f5}>$ (68F5)

Overexciting for example a transformer creates odd harmonics. This over excitation stage can be used detect overexcitation. This stage can also be used to block some other stages.

The ratio between the over excitation component and the fundamental frequency component is measured on all the phase currents. When the ratio in any phase exceeds the setting value, the stage gives a start signal. After a settable delay, the stage gives a trip signal.

The trip delay of the stages to be blocked must be more than 60 ms to ensure a proper blocking.

Table 5.16: Setting parameters of over excitation blocking (68F5)

Parameter	Value	Unit	Default	Description
If5>	10 – 100	%	10	Setting value If5/Ifund
t_f5	0.05 – 300.0	s	0.05	Definite operating time
S_On	Enabled; Disabled	-	Enabled	Start on event
S_Off	Enabled; Disabled	-	Enabled	Start off event
T_On	Enabled; Disabled	-	Enabled	Trip on event
T_Off	Enabled; Disabled	-	Enabled	Trip off event

For details of setting ranges, see Table 12.27.

Table 5.17: Measured and recorded values of over excitation blocking (68F5)

	Parameter	Value	Unit	Description
Measured values	IL1H5.		%	5. harmonic of IL1, proportional to the fundamental value of IL1
	IL2H5.		%	5. harmonic of IL2
	IL3H5.		%	5. harmonic of IL3
Recorded values	Flt		%	The max. fault value
	EDly		%	Elapsed time as compared to the set operating time; 100% = tripping

5.10 Circuit breaker failure protection CBFP (50BF)

The circuit breaker failure protection can be used to trip any upstream circuit breaker (CB), if the fault has not disappeared within a given time after the initial trip command. A different output contact of the device must be used for this backup trip.

The operation of the circuit-breaker failure protection (CBFP) is based on the supervision of the signal to the selected trip relay and the time the fault remains on after the trip command.

If this time is longer than the operating time of the CBFP stage, the CBFP stage activates another output relay, which will remain activated until the primary trip relay resets.

The CBFP stage is supervising all the protection stages using the same selected trip relay, since it supervises the control signal of this device. See Chapter 8.4 Output matrix

Table 5.18: Parameters of the circuit breaker failure stage CBFP (50BF)

Parameter	Value	Unit	Description	Note
Status	-		Current status of the stage	
	Blocked			
	Start			F
	Trip			F
SCntr			Cumulative start counter	C
TCntr			Cumulative trip counter	C
Force	Off		Force flag for status forcing for test purposes. This is a common flag for all stages and output relays, too. Automatically reset by a 5-minute timeout.	Set
	On			
Cbrelay			The supervised output relay*).	Set
	1		Relay T1	
	2		Relay T2	
t>		s	Definite operation time.	Set

Set = An editable parameter (password needed). C = Can be cleared to zero. F = Editable when force flag is on.

For details of setting ranges, see Table 12.25.

Recorded values of the latest eight faults

There are detailed information available of the eight latest faults:
Time stamp and elapsed delay.

Table 5.19: Recorded values of the circuit breaker failure stage (8 latest faults) CBFP (50BF)

Parameter	Value	Unit	Description
	yyyy-mm-dd		Time stamp of the recording, date
	hh:mm:ss.ms		Time stamp, time of day
EDly		%	Elapsed time of the operating time setting. 100% = trip

5.11 Programmable stages (99)

For special applications the user can built own protection stages by selecting the supervised signal and the comparison mode.

The following parameters are available:

- **Priority**
If operation times less than 80 milliseconds are needed select 10 ms. For operation times under one second 20 ms is recommended. For longer operation times and THD signals 100 ms is recommended.
- **Coupling A**
The name of the supervised signal in “>” and “<” modes (see table below). Also the name of the supervised signal 1 in “Diff” and “AbsDiff” modes.
- **Coupling B**
The name of the supervised signal 2 in “Diff” and “AbsDiff” modes.
- **Compare condition**
Compare mode. ‘>’ for over or ‘<’ for under comparison, “Diff” and “AbsDiff” for comparing Coupling A and Coupling B.
- **Pick-up**
Limit of the stage. The available setting range and the unit depend on the selected signal.
- **Operation delay**
Definite time operation delay
- **Hysteresis**
Dead band (hysteresis)
- **No Compare limit for mode <**
Only used with compare mode under (‘<’). This is the limit to start the comparison. Signal values under NoCmp are not regarded as fault.

Table 5.20: Available signals to be supervised by the programmable stages

Alarm stages link signals	Task interval
IL1 – IL3, IL1W – IL3W, I'L1W – I'L3W, IL, I'L Io1, Io2, localc, I'oCalc, I1, I2, I2/I1, I2/In, I'1, I'2, I'2/I'1, I'2/In, dIL1, dIL2, dIL3 THDIL1, THDIL2, THDIL3	100 ms
VAI1, VAI2, VAI3, VAI4, VAI5	Virtual analog inputs 1, 2, 3, 4, 5 (GOOSE)

Eight independent stages

The device has eight independent programmable stages. Each programmable stage can be enabled or disabled to fit the intended application.

Setting groups

There are four settings groups available. Switching between setting groups can be controlled by digital inputs, virtual inputs (mimic display, communication, logic) and manually.

There are four identical stages available with independent setting parameters.

See Chapter 5.2 General features of protection stages for more details.

Table 5.21: Parameters of the programmable stages PrgN (99)

Parameter	Value	Unit	Description	Note
Status	- Blocked Start Trip		Current status of the stage	 F F
SCntr			Cumulative start counter	C
TCntr			Cumulative trip counter	C
SetGrp	1, 2, 3, 4		Active setting group	Set
SGrpDI			Digital signal to select the active setting group	Set
	-		None	
	Dlx		Digital input	
	Vlx		Virtual input	
	LEDx		LED indicator signal	
Force	Off		Force flag for status forcing for test purposes. This is a common flag for all stages and output relays, too. Automatically reset by a 5-minute timeout.	Set
	On			
Link	See Table 5.20		Name for the supervised signal	
See Table 5.20			Value of the supervised signal	

Parameter	Value	Unit	Description	Note
Cmp			Mode of comparison	Set
	>		Over protection	
	<		Under protection	
	Diff		Difference	
	AbsDiff		Absolut difference	
Pickup			Pick up value scaled to primary level	
Pickup		pu	Pick up setting in pu	Set
t		s	Definite operation time.	Set
Hyster		%	Dead band setting	Set
NoCmp		pu	Minimum value to start under comparison. (Mode='<')	Set

Set = An editable parameter (password needed). C = Can be cleared to zero. F = Editable when force flag is on.

Recorded values of the latest eight faults

There is detailed information available of the eight latest faults: Time stamp, fault value and elapsed delay.

Table 5.22: Recorded values of the programmable stages PrgN (99)

Parameter	Value	Unit	Description
	yyyy-mm-dd		Time stamp of the recording, date
	hh:mm:ss.ms		Time stamp, time of day
Flt		pu	Fault value
EDly		%	Elapsed time of the operating time setting. 100% = trip
SetGrp	1, 2, 3, 4		Active setting group during fault

5.12 Arc fault protection (50ARC/50NARC) optional

NOTE: This protection function needs optional hardware in slot X6. More details of the hardware can be found in Chapter 11.4 Optional two channel arc protection card and Table 12.10).

Arc protection is used for fast arc protection. The function is based on simultaneous light and current measurement. Special arc sensors are used to measure the light of an arc.

Stages for arc faults

There are four separate stages for the various current inputs:

- Arcl>: for phase-to-phase arc faults. Current inputs I_{L1} , I_{L2} , I_{L3} are used.
- Arcl'>: for phase-to-phase arc faults. Current inputs $I'L1$, $I'L2$, $I'L3$ are used.
- Arcl₀₁>: for phase-to-earth arc faults. Current input I_{01} is used.
- Arcl₀₂>: for phase-to-earth arc faults. Current input I_{02} is used.

Light channel selection

The light information source to the stages can be selected from the following list.

- - : No sensor selected. The stage will not work.
- S1: Light sensor S1.
- S2: Light sensor S2.
- S1/S2: Either one of the light sensors S1 or S2.
- BI: Binary input of the arc card. 48 Vdc.
- S1/BI: Light sensor S1 or the binary input.
- S2/BI: Light sensor S2 or the binary input.
- S1/S2/BI: Light sensor S1 or S2 or the binary input.

Binary input

The binary input (BI) on the arc option card (see Chapter 11.4 Optional two channel arc protection card) can be used to get the light indication from another relay to build selective arc protection systems.

The BI signal can also be connected to any of the output relays, BO, indicators etc. offered by the output matrix (see Chapter 8.4 Output matrix). BI is a dry input for 48 Vdc signal from binary outputs of other VAMP devices or dedicated arc protection devices by VAMP.

Binary output

The binary output (BO) on the arc option card (see Chapter 11.4 Optional two channel arc protection card) can be used to give the light indication signal or any other signal or signals to another relay's binary input to build selective arc protection systems.

Selection of the BO connected signal(s) is done with the output matrix (see Chapter 8.4 Output matrix). BO is an internally wetted 48 Vdc signal for BI of other VAMP relays or dedicated arc protection devices by VAMP.

Delayed light indication signal

Relay output matrix has a delayed light indication output signal (Delayed Arc L>) available for building selective arc protection systems. Any light source combination and a delay can be configured starting from 0.01 s to 0.15 s. The resulting signal is available in the output matrix to be connected to BO, output relays etc.

Pick up scaling

The per unit (pu) values for pick up setting are based on the current transformer values.

Arcl>: 1 pu = 1 x I_N = rated phase current CT value

Arcl'>: 1 pu = 1 x I'_N = rated phase current CT value

Arcl₀₁>: 1 pu = 1 x I_{01N} = rated residual current CT value for input I_{01} .

Arcl₀₂>: 1 pu = 1 x I_{02N} = rated residual current CT value for input I_{02} .

Table 5.23: Parameters of arc protection stages Arcl>, Arcl'>, Arcl₀₁>, Arcl₀₂> (50ARC/50NARC)

Parameter	Value	Unit	Description	Note
Status	-		Current status of the stage	
	Start		Light detected according Arcl _N	F
	Trip		Light and overcurrent detected	F
LCntr			Cumulative light indication counter. S1, S2 or BI.	C
SCntr			Cumulative light indication counter for the selected inputs according parameter Arcl _N	C
TCntr			Cumulative trip counter	C
Force	Off		Force flag for status forcing for test purposes. This is a common flag for all stages and output relays, too. Automatically reset by a 5-minute timeout.	Set
	On			

Parameter	Value	Unit	Description	Note
ILmax			Value of the supervised signal	
I'Lmax			Stage Arcl>	
Io1			Stage Arcl'>	
Io2			Stage Arcl ₀₁ >	
Arcl>		pu	Pick up setting x I _N	Set
Arcl'>		pu	Pick up setting x I' _N	
Arcl ₀₁ >		pu	Pick up setting x I _{01N}	
Arcl ₀₂ >		pu	Pick up setting x I _{02N}	
Arcln			Light indication source selection	Set
	–		No sensor selected	
	S1		Sensor 1 at terminals X6:4 – 5	
	S2		Sensor 2 at terminals X6:6 – 7	
	S1/S2		Sensor in terminals 1 and 2	
	BI		Terminals X6:1 – 3	
	S1/BI		Sensor 1 and BI in use	
	S2/BI		Sensor 2 and BI in use	
	S1/S2/BI		Sensor 1, 2 and BI in use	
Delayed light signal output				
Ldly		s	Delay for delayed light output signal	Set
LdlyCn			Light indication source selection	Set
	–		No sensor selected	
	S1		Sensor 1 at terminals X6:4 – 5	
	S2		Sensor 2 at terminals X6:6 – 7	
	S1/S2		Sensor in terminals 1 and 2	
	BI		Terminals X6:1 – 3	
	S1/BI		Sensor 1 and BI in use	
	S2/BI		Sensor 2 and BI in use	
	S1/S2/BI		Sensor 1, 2 and BI in use	

Set = An editable parameter (password needed). C = Can be cleared to zero. F = Editable when force flag is on.

For details of setting ranges, see Table 12.28.

Recorded values of the latest eight faults

There is detailed information available of the eight latest faults: Time stamp, fault type, fault value, load current before the fault and elapsed delay.

Table 5.24: Recorded values of the arc protection stages

Parameter	Value	Unit	Description
	yyyy-mm-dd		Time stamp of the recording, date
	hh:mm:ss.ms		Time stamp, time of day
Type		pu	Fault type value. Only for Arcl> stage.
Flt		pu	Fault value
Load		pu	Pre fault current. Only for Arcl> stage.
EDly		%	Elapsed time of the operating time setting. 100% = trip

5.13 Inverse time operation

The inverse time operation - i.e. inverse definite minimum time (IDMT) type of operation - is available for several protection functions. The common principle, formulae and graphic representations of the available inverse delay types are described in this chapter.

Inverse delay means that the operation time depends on the measured real time process values during a fault. For example with an overcurrent stage using inverse delay a bigger a fault current gives faster operation. The alternative to inverse delay is definite delay. With definite delay a preset time is used and the operation time does not depend on the size of a fault.

Stage specific inverse delay

Some protection functions have their own specific type of inverse delay. Details of these dedicated inverse delays are described with the appropriate protection function.

Operation modes

There are three operation modes to use the inverse time characteristics:

- **Standard delays**
Using standard delay characteristics by selecting a curve family (IEC, IEEE, IEEE2, RI) and a delay type (Normal inverse, Very inverse etc). See Chapter 5.13.1 Standard inverse delays IEC, IEEE, IEEE2, RI.
- **Standard delay formulae with free parameters**
selecting a curve family (IEC, IEEE, IEEE2) and defining one's own parameters for the selected delay formula. This mode is activated by setting delay type to 'Parameters', and then editing the delay function parameters A – E. See Chapter 5.13.2 Free parameterization using IEC, IEEE and IEEE2 equations.
- **Fully programmable inverse delay characteristics**
Building the characteristics by setting 16 [current, time] points. The relay interpolates the values between given points with 2nd degree polynomials. This mode is activated by setting curve family to 'PrgN'. There are maximum three different programmable curves available at the same time. Each programmed curve can be used by any number of protection stages. See Chapter 5.13.3 Programmable inverse time curves.

Local panel graph

The device will show a graph of the currently used inverse delay on the local panel display. Up and down keys can be used for zooming. Also the delays at $20 \times I_{SET}$, $4 \times I_{SET}$ and $2 \times I_{SET}$ are shown.

Inverse time setting error signal

If there are any errors in the inverse delay configuration the appropriate protection stage will use definite time delay.

There is a signal 'Setting Error' available in output matrix, which indicates three different situations:

1. Settings are currently changed with VAMPSET or local panel, and there is temporarily an illegal combination of curve/delay/points. For example if previous settings were IEC/NI and then curve family is changed to IEEE, the setting error will be active, because there is no NI type available for IEEE curves. After changing valid delay type for IEEE mode (for example MI), the 'Setting Error' signal will release.
2. There are errors in formula parameters A – E, and the device is not able to build the delay curve
3. There are errors in the programmable curve configuration and the device is not able to interpolate values between the given points.

Limitation

The maximum measured phase current is $50 \times I_N$ and the maximum directly measured earth fault current is $5 \times I_{0N}$. This limits the scope of inverse curves when the setting is more than $2.5 \times I_N$ (overcurrent stages and earth fault stages using I_{0Calc} input) or $0.25 \times I_{01N}$ (earth fault stages using I_{01} input or I_{02} input). The I_N and I_{01N} and I_{02N} depend on the order code (See Chapter 14 Order information). The table below gives the limit values in secondary amperes.

Example of limitation

$$CT = 750 / 5$$

$$I_N = 577 \text{ A}$$

$$CT_0 = 100 / 1 \text{ (a cable CT for } I_0)$$

Secondary scaled I_{NSEC} is now 3.85 A

For 5 A CT secondaries and 1 A residual current inputs VAMP relay VAMP 265-5D7AAA is used. It has 5 A phase current inputs and 1 A residual inputs.

For overcurrent stage $I >$ the table below gives 12.5 A. Thus the maximum setting for $I >$ stage giving full inverse delay range is $12.5 \text{ A} / 3.85 \text{ A} = 3.25 \times I_N$.

For earth fault stage $I_0 >$ and input I_{01} the table below gives 0.25 A. Thus the maximum setting for $I_0 >$ stage giving full inverse delay range is $0.25 \text{ A} / 1 \text{ A} = 0.25 \text{ pu}$. This equals a 25 A primary earth fault current.

When using input signal I_{0Calc} the corresponding setting is 12.5 A / 1 A = 12.5 pu. This equals a 9375 A of primary earth fault current.

Order code	RATED INPUT				Maximum secondary scaled setting enabling inverse delay times up to 20 x setting			
	IL	I'L	I_{01}	I_{02}	IL1, IL2, IL3 & I_{0Calc}	I'L1, I'L2, I'L3 & I'_{0Calc}	I_{01}	I_{02}
VAMP 265-1_	1	1			2.5 A	2.5 A		
VAMP 265-3_	1	5			2.5 A	12.5 A		
VAMP 265-4_	5	1			12.5 A	2.5 A		
VAMP 265-5_	5	5			12.5 A	12.5 A		
VAMP 265-_A			5	5			1.25 A	1.25 A
VAMP 265-_B			5	1			1.25 A	0.25 A
VAMP 265-_C			1	5			0.25 A	1.25 A
VAMP 265-_D			1	1			0.25 A	0.25 A

5.13.1 Standard inverse delays IEC, IEEE, IEEE2, RI

The available standard inverse delays are divided in four categories IEC, IEEE, IEEE2 and RI called delay curve families. Each category of family contains a set of different delay types according the following table.

Inverse time setting error signal

The inverse time setting error signal will be activated, if the delay category is changed and the old delay type doesn't exist in the new category. See Chapter 5.13 Inverse time operation for more details.

Limitations

The minimum definite time delay start latest, when the measured value is twenty times the setting. However, there are limitations at high setting values due to the measurement range. Chapter 5.13 Inverse time operation for more details.

Table 5.25: Available standard delay families and the available delay types within each family.

Delay type		Curve family				
		DT	IEC	IEEE	IEEE2	RI
DT	Definite time	X				
NI	Normal inverse		X		X	
VI	Very inverse		X	X	X	
EI	Extremely inverse		X	X	X	
LTI	Long time inverse		X	X		
LTEI	Long time extremely inverse			X		
LTVI	Long time very inverse			X		
MI	Moderately inverse			X	X	
STI	Short time inverse			X		
STEI	Short time extremely inverse			X		
RI	Old ASEA type					X
RXIDG	Old ASEA type					X

IEC inverse time operation

The operation time depends on the measured value and other parameters according Equation 5.6. Actually this equation can only be used to draw graphs or when the measured value I is constant during the fault. A modified version is implemented in the relay for real time usage.

t = Operation delay in seconds

k = User's multiplier

I = Measured value

I_{PICKUP} = User's pick up setting

A, B = Constants parameters according Table 5.26.

Equation 5.6:

$$t = \frac{k A}{\left(\frac{I}{I_{PICKUP}}\right)^B - 1}$$

There are three different delay types according IEC 60255-3, Normal inverse (NI), Extremely inverse (EI), Very inverse (VI) and a VI extension. Additional there is a de facto standard Long time inverse (LTI).

Table 5.26: Constants for IEC inverse delay equation

Delay type		Parameter	
		A	B
NI	Normal inverse	0.14	0.02
EI	Extremely inverse	80	2
VI	Very inverse	13.5	1
LTI	Long time inverse	120	1

Example for Delay type "Normal inverse (NI)":

$k = 0.50$

$I = 4 \text{ pu (constant current)}$

$I_{\text{PICKUP}} = 2 \text{ pu}$

$A = 0.14$

$B = 0.02$

$$t = \frac{0.50 \cdot 0.14}{\left(\frac{4}{2}\right)^{0.02} - 1} = 5.0$$

The operation time in this example will be 5 seconds. The same result can be read from Figure 5.23.

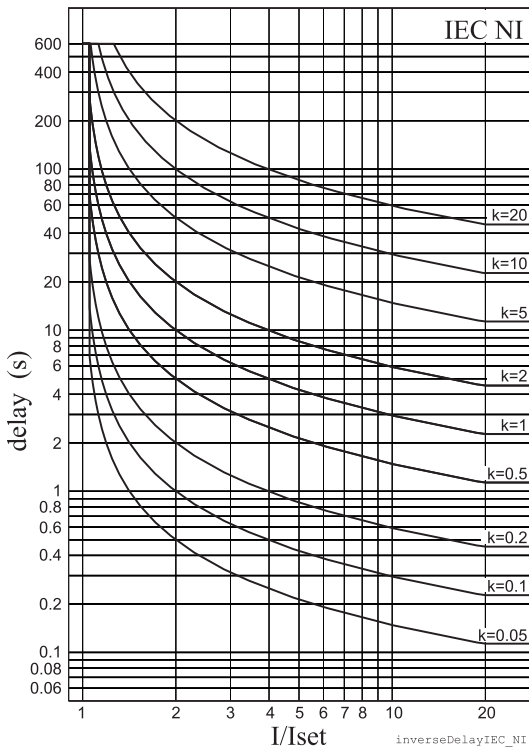

Figure 5.23: IEC normal inverse delay.

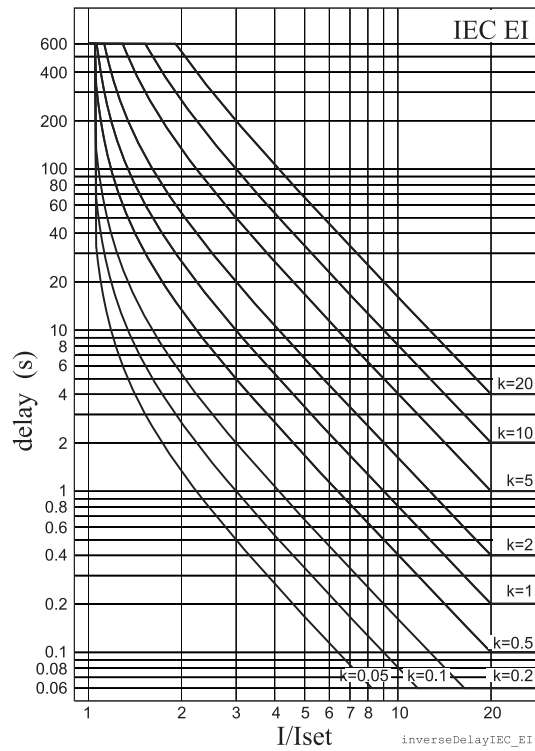

Figure 5.24: IEC extremely inverse delay.

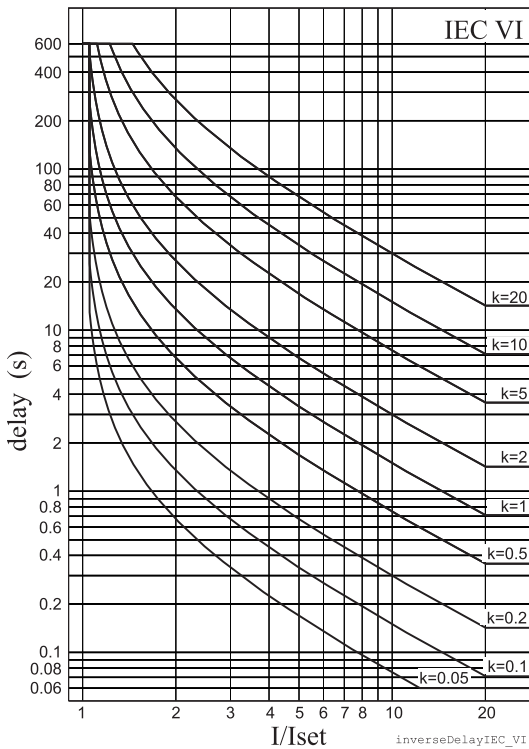

Figure 5.25: IEC very inverse delay.

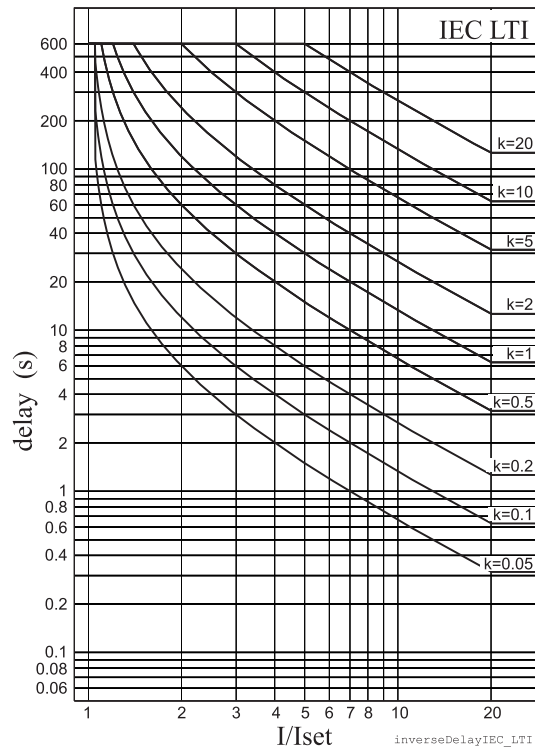

Figure 5.26: IEC long time inverse delay.

IEEE/ANSI inverse time operation

There are three different delay types according IEEE Std C37.112-1996 (MI, VI, EI) and many de facto versions according Table 5.27. The IEEE standard defines inverse delay for both trip and release operations. However, in the VAMP relay only the trip time is inverse according the standard but the release time is constant.

The operation delay depends on the measured value and other parameters according Equation 5.7. Actually this equation can only be used to draw graphs or when the measured value I is constant during the fault. A modified version is implemented in the relay for real time usage.

Equation 5.7:

$$t = k \left[\frac{A}{\left(\frac{I}{I_{PICKUP}} \right)^C} + B \right]$$

t = Operation delay in seconds

k = User's multiplier

I = Measured value

I_{PICKUP} = User's pick up setting

A,B,C = Constant parameter according Table 5.27.

Table 5.27: Constants for IEEE/ANSI inverse delay equation

Delay type		Parameter		
		A	B	C
LTI	Long time inverse	0.086	0.185	0.02
LTVI	Long time very inverse	28.55	0.712	2
LTEI	Long time extremely inverse	64.07	0.250	2
MI	Moderately inverse	0.0515	0.1140	0.02
VI	Very inverse	19.61	0.491	2
EI	Extremely inverse	28.2	0.1217	2
STI	Short time inverse	0.16758	0.11858	0.02
STEI	Short time extremely inverse	1.281	0.005	2

Example for Delay type "Moderately inverse (MI)":

$$k = 0.50$$

$$I = 4 \text{ pu}$$

$$I_{\text{PICKUP}} = 2 \text{ pu}$$

$$A = 0.0515$$

$$B = 0.114$$

$$C = 0.02$$

$$t = 0.50 \cdot \left[\frac{0.0515}{\left(\frac{4}{2}\right)^{0.02} - 1} + 0.1140 \right] = 1.9$$

The operation time in this example will be 1.9 seconds. The same result can be read from Figure 5.30.

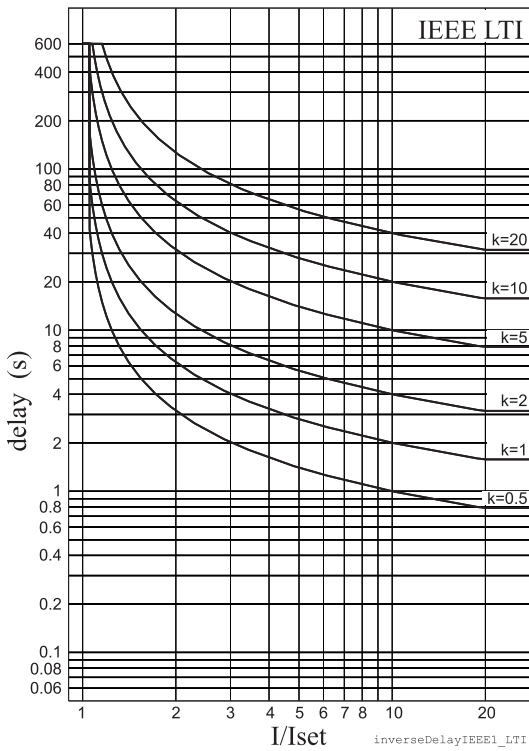

Figure 5.27: ANSI/IEEE long time inverse delay

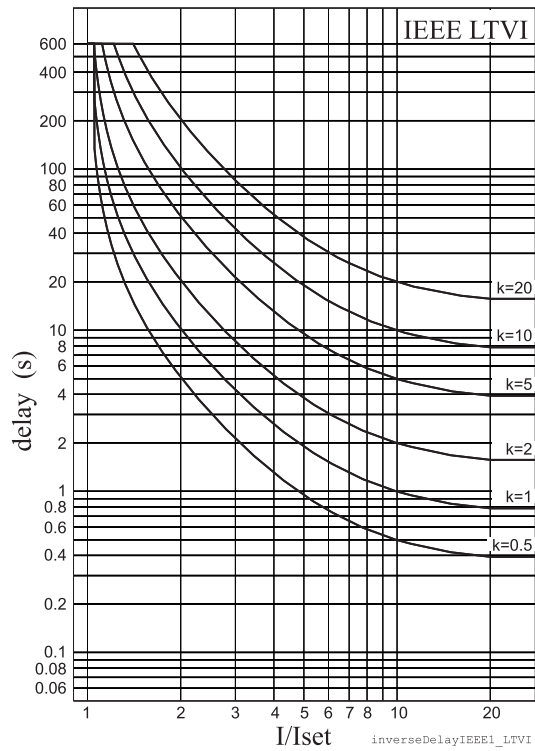

Figure 5.28: ANSI/IEEE long time very inverse delay

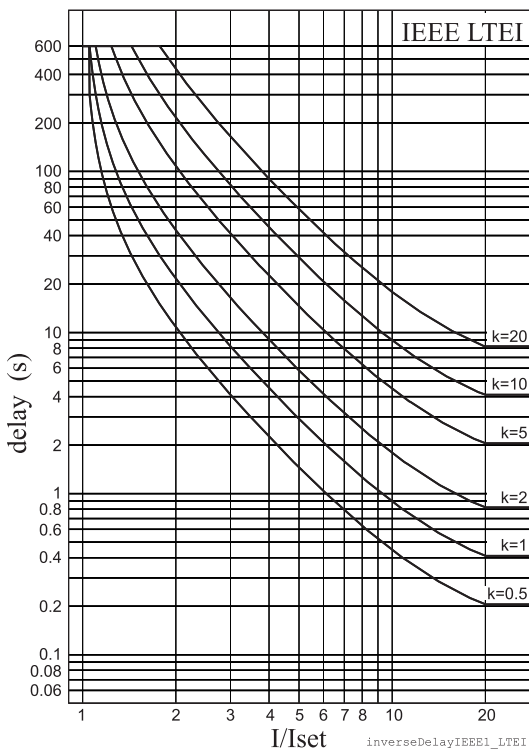

Figure 5.29: ANSI/IEEE long time extremely inverse delay

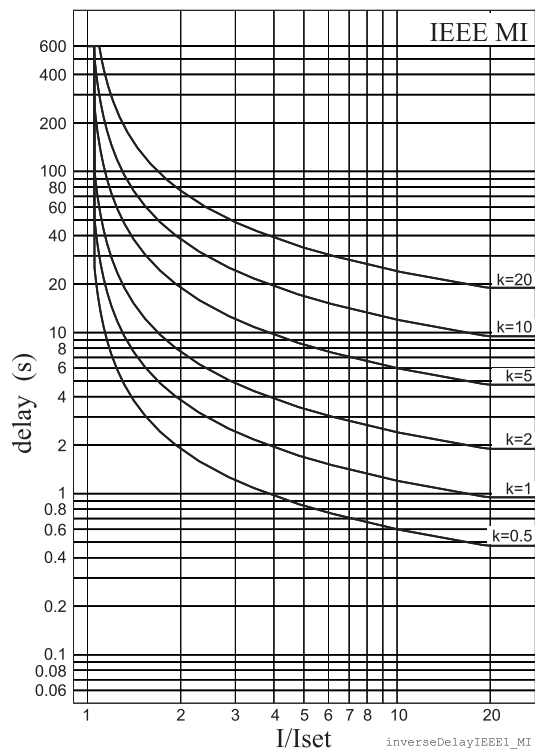

Figure 5.30: ANSI/IEEE moderately inverse delay

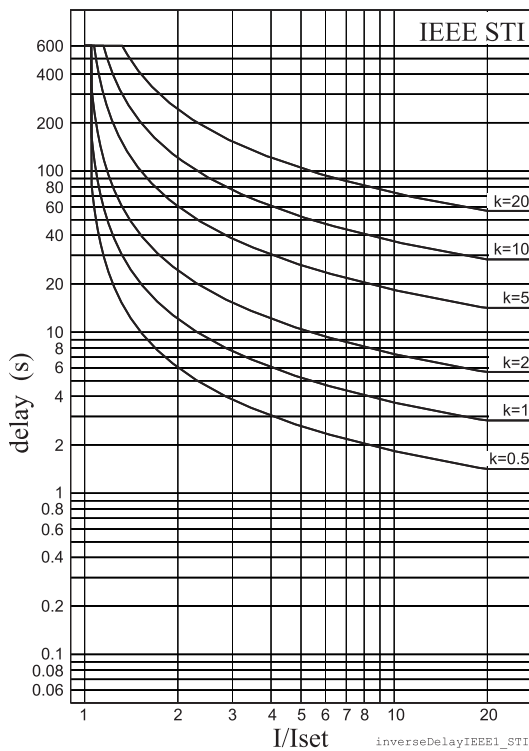

Figure 5.31: ANSI/IEEE short time inverse delay

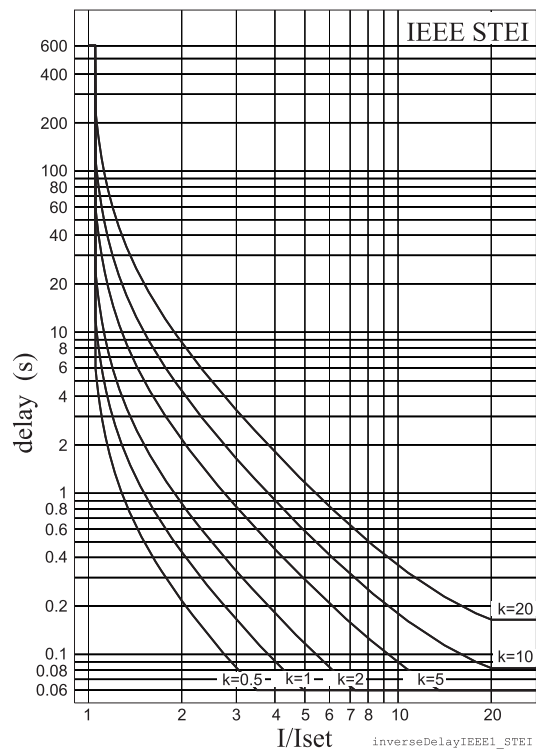

Figure 5.32: ANSI/IEEE short time extremely inverse delay

IEEE2 inverse time operation

Before the year 1996 and ANSI standard C37.112 microprocessor relays were using equations approximating the behaviour of various induction disc type relays. A quite popular approximation is Equation 5.8, which in VAMP relays is called IEEE2. Another name could be IAC, because the old General Electric IAC relays have been modeled using the same equation.

There are four different delay types according Table 5.28. The old electromechanical induction disc relays have inverse delay for both trip and release operations. However, in VAMP relays only the trip time is inverse the release time being constant.

The operation delay depends on the measured value and other parameters according Equation 5.8. Actually this equation can only be used to draw graphs or when the measured value I is constant during the fault. A modified version is implemented in the relay for real time usage.

Equation 5.8:

$$t = k \left[A + \frac{B}{\left(\frac{I}{I_{PICKUP}} - C \right)} + \frac{D}{\left(\frac{I}{I_{PICKUP}} - C \right)^2} + \frac{E}{\left(\frac{I}{I_{PICKUP}} - C \right)^3} \right]$$

t = Operation delay in seconds

k = User's multiplier

I = Measured value

I_{PICKUP} = User's pick up setting

A, B, C, D = Constant parameter according Table 5.28.

Table 5.28: Constants for IEEE2 inverse delay equation

Delay type		Parameter				
		A	B	C	D	E
MI	Moderately inverse	0.1735	0.6791	0.8	-0.08	0.1271
NI	Normally inverse	0.0274	2.2614	0.3	-0.1899	9.1272
VI	Very inverse	0.0615	0.7989	0.34	-0.284	4.0505
EI	Extremely inverse	0.0399	0.2294	0.5	3.0094	0.7222

Example for Delay type "Moderately inverse (MI)":

k = 0.50

I = 4 pu

I_{PICKUP} = 2 pu

A = 0.1735

B = 0.6791

C = 0.8

D = -0.08

E = 0.127

$$t = 0.5 \cdot \left[0.1735 + \frac{0.6791}{\left(\frac{4}{2} - 0.8 \right)} + \frac{-0.08}{\left(\frac{4}{2} - 0.8 \right)^2} + \frac{0.127}{\left(\frac{4}{2} - 0.8 \right)^3} \right] = 0.38$$

The operation time in this example will be 0.38 seconds. The same result can be read from Figure 5.33.

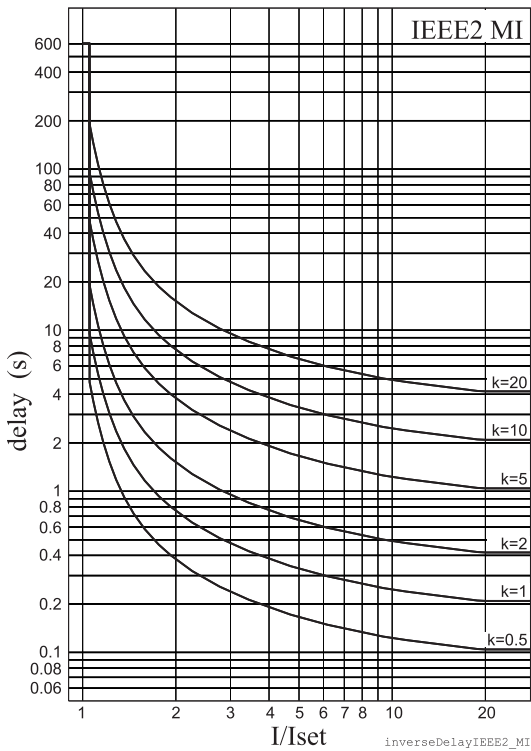

Figure 5.33: IEEE2 moderately inverse delay

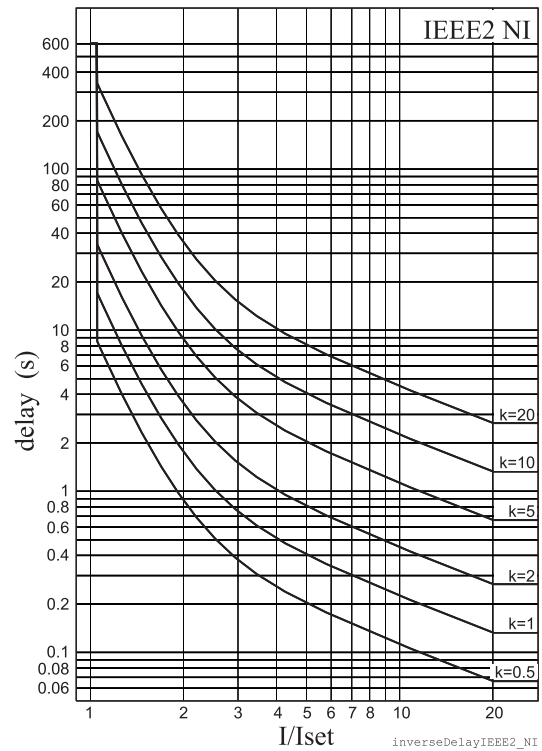

Figure 5.34: IEEE2 normal inverse delay

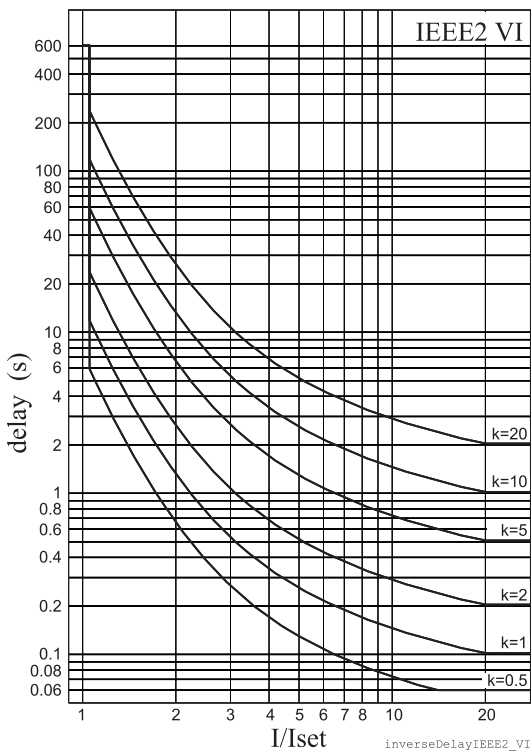

Figure 5.35: IEEE2 very inverse delay

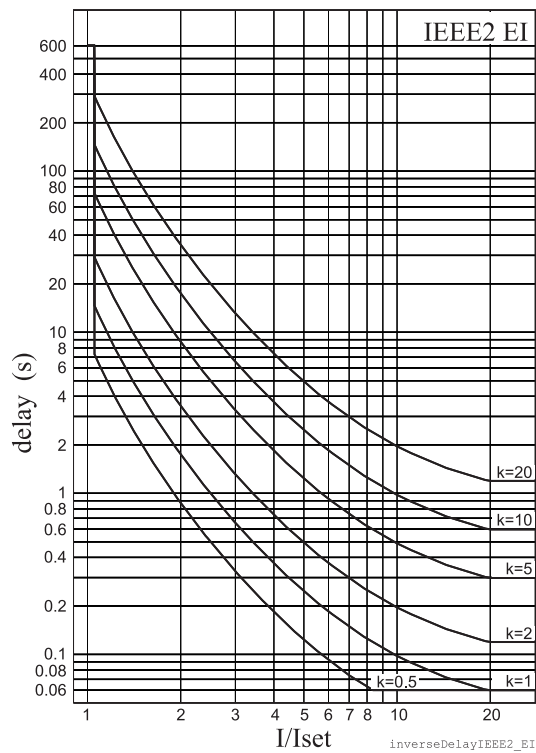

Figure 5.36: IEEE2 extremely inverse delay

RI and RXIDG type inverse time operation

These two inverse delay types have their origin in old ASEA (nowadays ABB) earth fault relays.

The operation delay of types RI and RXIDG depends on the measured value and other parameters according Equation 5.9 and Equation 5.10. Actually these equations can only be used to draw graphs or when the measured value I is constant during the fault. Modified versions are implemented in the relay for real time usage.

Equation 5.9: RI

$$t_{RI} = \frac{k}{0.339 - \frac{0.236}{\left(\frac{I}{I_{PICKUP}}\right)}}$$

Equation 5.10: RXIDG

$$t_{RXIDG} = 5.8 - 1.35 \ln \frac{I}{k I_{PICKUP}}$$

t = Operation delay in seconds

k = User's multiplier

I = Measured value

I_{PICKUP} = User's pick up setting

Example for Delay type RI

$k = 0.50$

$I = 4$ pu

$I_{PICKUP} = 2$ pu

$$t_{RI} = \frac{0.5}{0.339 - \frac{0.236}{\left(\frac{4}{2}\right)}} = 2.3$$

The operation time in this example will be 2.3 seconds. The same result can be read from Figure 5.37.

Example for Delay type RXIDG

$k = 0.50$

$I = 4$ pu

$I_{PICKUP} = 2$ pu

$$t_{RXIDG} = 5.8 - 1.35 \ln \frac{4}{0.5 \cdot 2} = 3.9$$

The operation time in this example will be 3.9 seconds. The same result can be read from Figure 5.38.

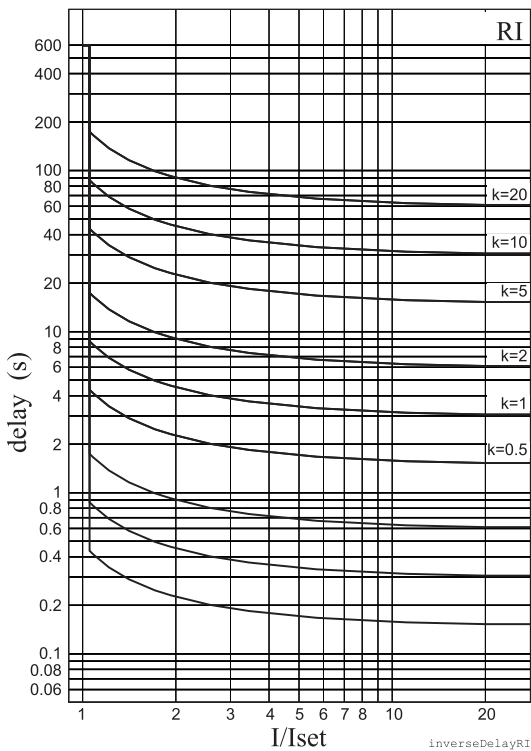

Figure 5.37: Inverse delay of type RI.

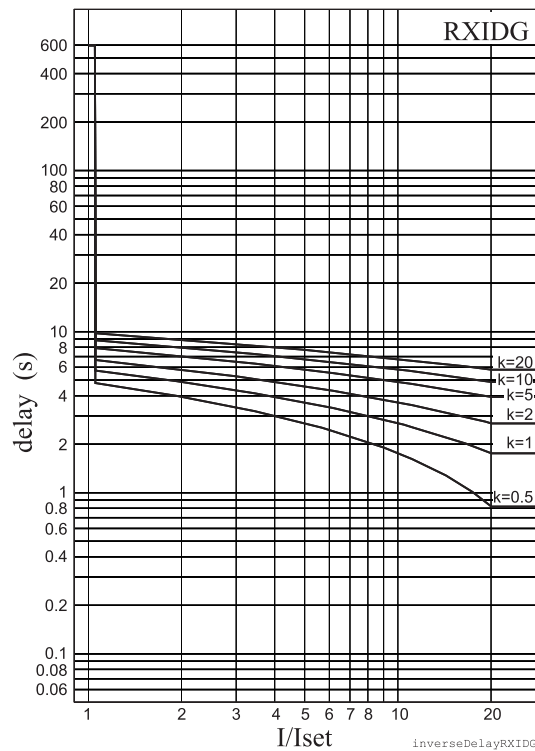

Figure 5.38: Inverse delay of type RXIDG.

5.13.2 Free parameterization using IEC, IEEE and IEEE2 equations

This mode is activated by setting delay type to 'Parameters', and then editing the delay function constants, i.e. the parameters A – E. The idea is to use the standard equations with one's own constants instead of the standardized constants as in the previous chapter.

Example for GE-IAC51 delay type inverse:

$$k = 0.50$$

$$I = 4 \text{ pu}$$

$$I_{\text{PICKUP}} = 2 \text{ pu}$$

$$A = 0.2078$$

$$B = 0.8630$$

$$C = 0.8000$$

$$D = -0.4180$$

$$E = 0.1947$$

$$t = 0.5 \cdot \left[0.2078 + \frac{0.8630}{\left(\frac{4}{2} - 0.8\right)} + \frac{-0.4180}{\left(\frac{4}{2} - 0.8\right)^2} + \frac{0.1947}{\left(\frac{4}{2} - 0.8\right)^3} \right] = 0.37$$

The operation time in this example will be 0.37 seconds.

The resulting time/current characteristic of this example matches quite well with the characteristic of the old electromechanical IAC51 induction disc relay.

Inverse time setting error signal

The inverse time setting error signal will become active, if interpolation with the given parameters is not possible. See Chapter 5.13 Inverse time operation for more details.

Limitations

The minimum definite time delay start latest, when the measured value is twenty times the setting. However, there are limitations at high setting values due to the measurement range. See Chapter 5.13 Inverse time operation for more details.

5.13.3

Programmable inverse time curves

Only with VAMPSET, requires rebooting.

The [current, time] curve points are programmed using VAMPSET PC program. There are some rules for defining the curve points:

- configuration must begin from the topmost line
- line order must be as follows: the smallest current (longest operation time) on the top and the largest current (shortest operation time) on the bottom
- all unused lines (on the bottom) should be filled with [1.00 0.00s]

Here is an example configuration of curve points:

Point	Current I/I _{PICKUP}	Operation delay
1	1.00	10.00 s
2	2.00	6.50 s
3	5.00	4.00 s
4	10.00	3.00 s
5	20.00	2.00 s
6	40.00	1.00 s
7	1.00	0.00 s
8	1.00	0.00 s
9	1.00	0.00 s

Point	Current I/I_{PICKUP}	Operation delay
10	1.00	0.00 s
11	1.00	0.00 s
12	1.00	0.00 s
13	1.00	0.00 s
14	1.00	0.00 s
15	1.00	0.00 s
16	1.00	0.00 s

Inverse time setting error signal

The inverse time setting error signal will be activated, if interpolation with the given points fails. See Chapter 5.13 Inverse time operation for more details.

Limitations

The minimum definite time delay start latest, when the measured value is twenty times the setting. However, there are limitations at high setting values due to the measurement range. See Chapter 5.13 Inverse time operation for more details.

6 Supporting functions

6.1 Event log

Event log is a buffer of event codes and time stamps including date and time. For example each start-on, start-off, trip-on or trip-off of any protection stage has a unique event number code. Such a code and the corresponding time stamp is called an event.

As an example of information included with a typical event an overvoltage trip event of the first 59 stage U> is shown in the following table.

EVENT	Description	Local panel	Communication protocols
Code: 01E02	Channel 1, event 2	Yes	Yes
I> trip on	Event text	Yes	No
1.2 x In	Fault value	Yes	No
2007-01-31	Date	Yes	Yes
08:35:13.413	Time	Yes	Yes
Type: 1 – 2	Fault type	Yes	No

Events are the major data for a SCADA system. SCADA systems are reading events using any of the available communication protocols. Event log can also be scanned using the front panel or using VAMPSET. With VAMPSET the events can be stored to a file especially in case the relay is not connected to any SCADA system.

Only the latest event can be read when using communication protocols or VAMPSET. Every reading increments the internal read pointer to the event buffer. (In case of communication interruptions, the latest event can be reread any number of times using another parameter.) On the local panel scanning the event buffer back and forth is possible.

Event enabling/masking

In case of an uninteresting event, it can be masked, which prevents the particular event(s) to be written in the event buffer. As a default there is room for 200 latest events in the buffer. Event buffer size can be modified from 50 to 2000.

Modification can be done in “Local panel conf” –menu.

Indication screen (popup screen) can also be enabled in this same menu when VAMPSET –setting tool is used. The oldest one will be overwritten, when a new event does occur. The shown resolution of a time stamp is one millisecond, but the actual resolution depends of the particular function creating the event. For example most protection stages create events with 5ms, 10 ms or 20 ms resolution.

The absolute accuracy of all time stamps depends on the time synchronizing of the relay. See Chapter 6.5 System clock and synchronization for system clock synchronizing.

Event buffer overflow

The normal procedure is to poll events from the device all the time. If this is not done then the event buffer could reach its limits. In such case the oldest event is deleted and the newest displayed with OVF code in HMI.

Table 6.1: Setting parameters for events

Parameter	Value	Description	Note
Count		Number of events	
ClrEn	- Clear	Clear event buffer	Set
Order	Old-New New-Old	Order of the event buffer for local display	Set
FVSca		Scaling of event fault value	Set
	PU	Per unit scaling	
	Pri	Primary scaling	
Display	On	Indication display is enabled	Set
Alarms	Off	No indication display	
FORMAT OF EVENTS ON THE LOCAL DISPLAY			
Code: CHENN		CH = event channel, NN=event code	
Event description		Event channel and code in plain text	
yyyy-mm-dd		Date (for available date formats, see Chapter 6.5 System clock and synchronization)	
hh:mm:ss.nnn		Time	

6.2 Disturbance recorder

The disturbance recorder can be used to record all the measured signals, that is, currents, voltage and the status information of digital inputs (DI) and digital outputs (DO).

The digital inputs include also the arc protection signals S1, S2, BI and BO, if the optional arc protection is available.

Triggering the recorder

The recorder can be triggered by any start or trip signal from any protection stage or by a digital input. The triggering signal is selected in the output matrix (vertical signal DR). The recording can also be triggered manually. All recordings are time stamped.

Reading recordings

The recordings can be uploaded, viewed and analysed with the VAMPSET program. The recording is in COMTRADE format. This also means that other programs can be used to view and analyse the recordings made by the relay.

For more details, please see a separate VAMPSET manual.

Number of channels

At the maximum, there can be 12 recordings, and the maximum selection of channels in one recording 12 (limited in wave form) and digital inputs reserve one channel (includes all the inputs). Also the digital outputs reserve one channel (includes all the outputs). If digital inputs and outputs are recorded, there will be still 10 channels left for analogue waveforms.

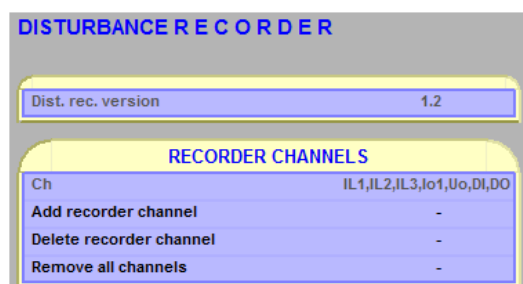

Table 6.2: VAMP 265 Disturbance recorder waveform

Channel	Description	Available for waveform
IL1, IL2, IL3	Phase current	Yes
I'L1, I'L2, I'L3	Phase current	Yes
Io1, Io2	Measured residual current	Yes
f	Frequency	-
IoCalc	Phasor sum $I_o = (IL1 + IL2 + IL3) / 3$	-
I'oCalc	Phasor sum $I'_o = (I'L1 + I'L2 + I'L3) / 3$	-
I1, I'1	Positive sequence current	-
I2, I'2	Negative sequence current	-
I2/I1, I'2/I'1	Relative current unbalance	-
I2/In, I'2/I'n	Current unbalance [$\times I_N$]	-
IL	Average $(IL1 + IL2 + IL3) / 3$	-
I'L	Average $(I'L1 + I'L2 + I'L3) / 3$	-
DO	Digital outputs	Yes
DI	Digital inputs	Yes
THDIL1	Total harmonic distortion of IL1	-
THDI'L1	Total harmonic distortion of I'L1	-
THDIL2	Total harmonic distortion of IL2	-
THDI'L2	Total harmonic distortion of I'L2	-
THDIL3	Total harmonic distortion of IL3	-
THDI'L3	Total harmonic distortion of I'L3	-
IL1RMS	IL1 RMS for average sampling	-
IL2RMS	IL2 RMS for average sampling	-
IL3RMS	IL3 RMS for average sampling	-
ILmin		
I'Lmin		
ILmax		
I'Lmax		
$\Delta IL1, \Delta IL2, \Delta IL3$		
IL1w, IL2w, IL3w		
I'L1w, I'L2w, I'L3w		

Table 6.3: Disturbance recorder parameters

Parameter	Value	Unit	Description	Note
Mode			Behavior in memory full situation:	Set
	Saturated		No more recordings are accepted	
	Overflow		The oldest recorder will be overwritten	
SR			Sample rate	Set
	32/cycle		Waveform	
	16/cycle		Waveform	
	8/cycle		Waveform	
	1/10ms		One cycle value *)	
	1/20ms		One cycle value **)	
	1/200ms		Average	
	1/1s		Average	
	1/5s		Average	
	1/10s		Average	
	1/15s		Average	
	1/30s		Average	
	1/1min		Average	
Time		s	Recording length	Set
PreTrig		%	Amount of recording data before the trig moment	Set
MaxLen		s	Maximum time setting. This value depends on sample rate, number and type of the selected channels and the configured recording length.	
Status			Status of recording	
	-		Not active	
	Run		Waiting a triggering	
	Trig		Recording	
	FULL		Memory is full in saturated mode	
ManTrig	-, Trig		Manual triggering	Set
ReadyRec	n/m		n = Available recordings / m = maximum number of recordings The value of 'm' depends on sample rate, number and type of the selected channels and the configured recording length.	

Parameter	Value	Unit	Description	Note
AddCh			Add one channel. Maximum simultaneous number of channels is 12.	Set
	IL1, IL2, IL3		Phase current (HV side)	
	I'L1, I'L2, I'L3		Phase current (IV side)	
	Io1, Io2		Measured residual current	
	f		Frequency	
	IoCalc		Phasor sum $I_o = (I_{L1} + I_{L2} + I_{L3}) / 3$ (HV side)	
	I1		Positive sequence current (HV side)	
	I2		Negative sequence current (HV side)	
	I2/I1		Relative current unbalance (HV side)	
	I2/I _n		Current unbalance [$\times I_N$] (HV side)	
	I'1		Positive sequence current (LV side)	
	I'2		Negative sequence current (LV side)	
	I'2/I'1		Relative current unbalance (LV side)	
	I'2/I'n		Current unbalance [$\times I'_N$] (LV side)	
	I'oCalc		Phasor sum $I_o = (I'_{L1} + I'_{L2} + I'_{L3}) / 3$ (LV side)	
	IL		Average $(IL1 + IL2 + IL3) / 3$	
	I'L		Average $(I'L1 + I'L2 + I'L3) / 3$	
	DI, DO		Digital inputs, Digital outputs	
	THDIL1, THDIL2, THDIL3		Total harmonic distortion of IL1, IL2 or IL3	
	IL1RMS, IL2MRS, IL3RMS		IL1, IL2, IL3 RMS for average sampling	
	ILmin, ILmax		Min and max of phase currents (HV side)	
	I'Lmin, I'Lmax		Min and max of phase currents (LV side)	
	Δ IL1, Δ IL2, Δ IL3		Differential current	
	IL1w, IL2w, IL3w		Winding current (HV side)	
	I'L1w, I'L2w, I'L3w		Winding current (LV side)	
	Starts		Protection stage start signals	
	Trips		Protection stage trip signals	
Delete recorder channel		Delete selected channel		
ClrCh	-, Clear		Remove all channels	Set
(Ch)			List of selected channels	

Set = An editable parameter (password needed).

*) This is the fundamental frequency rms value of one cycle updated every 10 ms.

**) This is the fundamental frequency rms value of one cycle updated every 20 ms.

For details of setting ranges, see Table 12.29.

6.2.1 Running virtual comtrade files

Virtual comtrade files can be run with VAMP relays with the v.10.74 software or a later version. Relay behaviour can be analysed by playing the recorder data over and over again in the relay memory.

Steps of opening the VAMPSET setting tool:

1. Go to “Disturbance record” and select Open... (A).
2. Select the comtrade file from you hard disc or equivalent. VAMPSET is now ready to read the recording.
3. The virtual measurement has to be enabled (B) in order to send record data to the relay (C).
4. Sending the file to the device’s memory takes a few seconds. Initiate playback of the file by pressing the Go! button (D). The “Change to control mode” button takes you back to the virtual measurement.

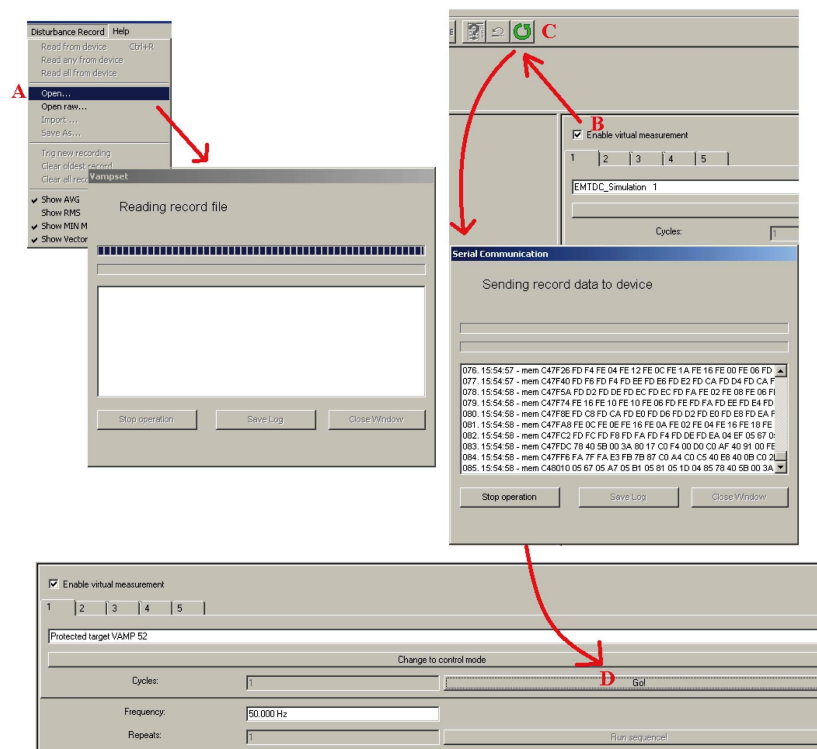

NOTE: The sample rate of the comtrade file has to be 32/cycle (625 micro seconds when 50 Hz is used). The channel names have to correspond to the channel names in VAMP relays: I_{L1} , I_{L2} , I_{L3} , I_{01} , I_{02} , U_{12} , U_{23} , U_{L1} , U_{L2} , U_{L3} and U_0 .

6.3 Current transformer supervision

The relay supervise the external wiring between the relay terminals and current transformers (CT) and the CT themselves. Furthermore, this is a safety function as well, since an open secondary of a CT, causes dangerous voltages.

The CT supervisor function measures phase currents. If one of the three phase currents drops below $I_{MIN}<$ setting, while another phase current is exceeding the $I_{MAX}>$ setting, the function will issue an alarm after the operation delay has elapsed.

Table 6.4: Setting parameters of CT, CT' supervisor CTSV

Parameter	Value	Unit	Default	Description
I _{max} >	0.0 – 10.0	xIn	2.0	Upper setting for CT supervisor current scaled to primary value, calculated by relay
I _{min} <	0.0 – 10.0	xIn	0.2	Lower setting for CT supervisor current scaled to primary value, calculated by relay
t>	0.02 – 600.0	s	0.10	Operation delay
CT on	On; Off	-	On	CT supervisor on event
CT off	On; Off	-	On	CT supervisor off event

Table 6.5: Measured and recorded values of CT, CT' supervisor CTSV

	Parameter	Value	Unit	Description
Measured value	IL _{max}		A	Maximum of phase currents
	IL _{min}		A	Minimum of phase currents
Display	I _{max} >, I _{min} <		A	Setting values as primary values
Recorded values	Date		-	Date of CT supervision alarm
	Time		-	Time of CT supervision alarm
	I _{max}		A	Maximum phase current
	I _{min}		A	Minimum phase current

For details of setting ranges, see Table 12.30.

6.4 Circuit breaker condition monitoring

The relay has a condition monitoring function that supervises the wearing of the circuit-breaker. The condition monitoring can give alarm for the need of CB maintenance well before the CB condition is critical.

The CB wear function measures the breaking current of each CB pole separately and then estimates the wearing of the CB accordingly the permissible cycle diagram. The breaking current is registered when the trip relay supervised by the circuit breaker failure protection (CBFP) is activated. (See Chapter 5.10 Circuit breaker failure protection CBFP (50BF) for CBFP and the setting parameter "CBrelay".)

Breaker curve and its approximation

The permissible cycle diagram is usually available in the documentation of the CB manufacturer (Figure 6.1). The diagram specifies the permissible number of cycles for every level of the breaking current. This diagram is parameterised to the condition monitoring function with maximum eight [current, cycles] points. See Table 6.6. If less than eight points needed, the unused points are set to $[I_{BIG}, 1]$, where I_{BIG} is more than the maximum breaking capacity.

If the CB wearing characteristics or part of it is a straight line on a log/log graph, the two end points are enough to define that part of the characteristics. This is because the relay is using logarithmic interpolation for any current values falling in between the given current points 2 – 8.

The points 4 – 8 are not needed for the CB in Figure 6.1. Thus they are set to 100 kA and one operation in the table to be discarded by the algorithm.

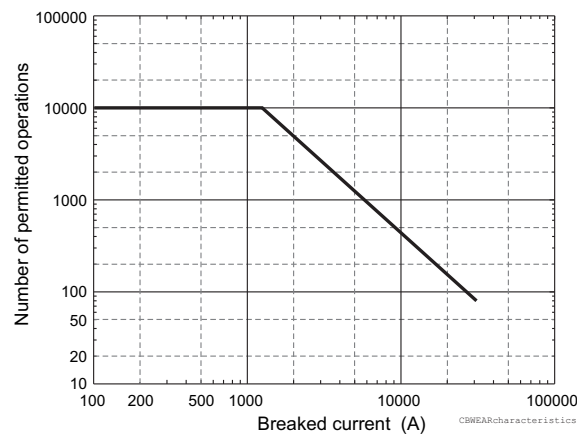

Figure 6.1: An example of a circuit breaker wearing characteristic graph.

Table 6.6: An example of circuit breaker wearing characteristics in a table format. The values are taken from the figure above. The table is edited with VAMPSET under menu "BREAKER CURVE".

Point	Interrupted current (kA)	Number of permitted operations
1	0 (mechanical age)	10000
2	1.25 (rated current)	10000
3	31.0 (maximum breaking current)	80
4	100	1
5	100	1
6	100	1
7	100	1
8	100	1

Setting alarm points

There are two alarm points available having two setting parameters each.

- Current
The first alarm can be set for example to nominal current of the CB or any application typical current. The second alarm can be set for example according a typical fault current.
- Operations left alarm limit
An alarm is activated when there are less operation left at the given current level than this limit.

Any actual interrupted current will be logarithmically weighted for the two given alarm current levels and the number of operations left at the alarm points is decreased accordingly. When the "operations left" i.e. the number of remaining operations, goes under the given alarm limit, an alarm signal is issued to the output matrix. Also an event is generated depending on the event enabling.

Clearing "operations left" counters

After the breaker curve table is filled and the alarm currents are defined, the wearing function can be initialised by clearing the decreasing operation counters with parameter "Clear" (Clear oper. left cntrs). After clearing the relay will show the maximum allowed operations for the defined alarm current levels.

Operation counters to monitor the wearing

The operations left can be read from the counters "AI1Ln" (Alarm 1) and "AI2Ln" (Alarm2). There are three values for both alarms, one for each phase. The smallest of three is supervised by the two alarm functions.

Logarithmic interpolation

The permitted number of operations for currents in between the defined points are logarithmically interpolated using equation

Equation 6.1:

$$C = \frac{a}{I^n}$$

C = permitted operations

I = interrupted current

a = constant according Equation 6.2

n = constant according Equation 6.3

Equation 6.2:

$$n = \frac{\ln \frac{C_k}{C_{k+1}}}{\ln \frac{I_{k+1}}{I_k}}$$

Equation 6.3:

$$a = C_k I_k^2$$

ln = natural logarithm function

 C_k, C_{k+1} = permitted operations. k = row 2 – 7 in Table 6.6. I_k, I_{k+1} = corresponding current. k = row 2 – 7 in Table 6.6.

Example of the logarithmic interpolation

Alarm 2 current is set to 6 kA. What is the maximum number of operations according Table 6.6.

The current 6 kA lies between points 2 and 3 in the table. That gives value for the index k . Using

$$k = 2$$

$$C_k = 10000$$

$$C_{k+1} = 80$$

$$I_{k+1} = 31 \text{ kA}$$

$$I_k = 1.25 \text{ kA}$$

and the Equation 6.2 and Equation 6.3, the relay calculates

$$n = \frac{\ln \frac{10000}{80}}{\ln \frac{31000}{1250}} = 1.5038$$

$$a = 10000 \cdot 1250^{1.5038} = 454 \cdot 10^6$$

Using Equation 6.1 the relay gets the number of permitted operations for current 6 kA.

$$C = \frac{454 \cdot 10^6}{6000^{1.5038}} = 945$$

Thus the maximum number of current breaking at 6 kA is 945. This can be verified with the original breaker curve in Figure 6.1. Indeed, the figure shows that at 6 kA the operation count is between 900 and 1000. A useful alarm level for operation-left, could be in this case for example 50 being about five per cent of the maximum.

Example of operation counter decrementing when the CB is breaking a current

Alarm2 is set to 6 kA. CBFP is supervising trip relay T1 and trip signal of an overcurrent stage detecting a two phase fault is connected to this trip relay T1. The interrupted phase currents are 12.5 kA, 12.5 kA and 1.5 kA. How many are Alarm2 counters decremented?

Using Equation 6.1 and values n and a from the previous example, the relay gets the number of permitted operation at 10 kA.

$$C_{10kA} = \frac{454 \cdot 10^6}{12500^{1.5038}} = 313$$

At alarm level 2, 6 kA, the corresponding number of operations is calculated according

Equation 6.4:

$$\Delta = \frac{C_{AlarmMax}}{C}$$

$$\Delta_{L1} = \Delta_{L2} = \frac{945}{313} = 3$$

Thus Alarm2 counters for phases L1 and L2 are decremented by 3. In phase L1 the currents is less than the alarm limit current 6 kA. For such currents the decrement is one.

$$\Delta_{L3} = 1$$

Table 6.7: Local panel parameters of CBWEAR function

Parameter	Value	Unit	Description	Set
CBWEAR STATUS				
AI1L1			Operations left for - Alarm 1, phase L1	
AI1L2			- Alarm 1, phase L2	
AI1L3			- Alarm 1, phase L3	
AI2L1			- Alarm 2, phase L1	
AI2L2			- Alarm 2, phase L2	
AI2L3			- Alarm 2, phase L3	
Latest trip				
Date time			Time stamp of the latest trip operation	
IL1		A	Broken current of phase L1	
IL2		A	Broken current of phase L2	
IL3		A	Broken current of phase L3	
CBWEAR SET				
Alarm1				
Current	0.00 – 100.00	kA	Alarm1 current level	Set
Cycles	100000 – 1		Alarm1 limit for operations left	Set
Alarm2				
Current	0.00 – 100.00	kA	Alarm2 current level	Set
Cycles	100000 – 1		Alarm2 limit for operations left	Set
CBWEAR SET2				
AI1On	On ; Off		'Alarm1 on' event enabling	Set
AI1Off	On ; Off		'Alarm1 off' event enabling	Set
AI2On	On ; Off		'Alarm2 on' event enabling	Set
AI2Off	On ; Off		'Alarm2 off' event enabling	Set
Clear	-; Clear		Clearing of cycle counters	Set

Set = An editable parameter (password needed).

The breaker curve table is edited with VAMPSET.

6.5 System clock and synchronization

The internal clock of the relay is used to time stamp events and disturbance recordings.

The system clock should be externally synchronised to get comparable event time stamps for all the relays in the system.

The synchronizing is based on the difference of the internal time and the synchronising message or pulse. This deviation is filtered and the internal time is corrected softly towards a zero deviation.

Time zone offsets

Time zone offset (or bias) can be provided to adjust the local time for IED. The Offset can be set as a Positive (+) or Negative (-) value within a range of -15.00 to +15.00 hours and a resolution of 0.01/h. Basically quarter hour resolution is enough.

Daylight saving time (DST)

IED provides automatic daylight saving adjustments when configured. A daylight savings time (summer time) adjustment can be configured separately and in addition to a time zone offset.

SYSTEM CLOCK	
Date	2014-05-12
Day of week	Monday
Time of day	15:24:47
Date style	y-m-d
Time zone	2 h
Enable DST	<input checked="" type="checkbox"/>
Event enabling	<input checked="" type="checkbox"/>
Status of DST	
Status of DST	ACTIVE
Next DST changes	
Next DSTbegin date	2015-03-29
DSTbegin hour	03:00
Next DSTend date	2014-10-26
DSTend hour (DST)	04:00 DST

Daylight time standards vary widely throughout the world. Traditional daylight/summer time is configured as one (1) hour positive bias. The new US/Canada DST standard, adopted in the spring of 2007 is: one (1) hour positive bias, starting at 2:00am on the second Sunday in March, and ending at 2:00am on the first Sunday in November. In the European Union, daylight change times are defined relative to the UTC time of day instead of local time of day (as in U.S.) European customers, please carefully find out local country rules for DST.

The daylight saving rules for Finland are the IED defaults (24-hour clock):

- Daylight saving time start: Last Sunday of March at 03.00
- Daylight saving time end: Last Sunday of October at 04.00

DSTbegin rule	
DSTbegin month	Mar
Ordinal of day of week	Last
Day of week	Sunday
DSTbegin hour	3

DSTend rule	
DSTend month	Oct
Ordinal of day of week	Last
Day of week	Sunday
DSTend hour (DST)	4 DST

To ensure proper hands-free year-around operation, automatic daylight time adjustments must be configured using the “Enable DST” and not with the time zone offset option.

Adapting auto adjust

During tens of hours of synchronizing the device will learn its average deviation and starts to make small corrections by itself. The target is that when the next synchronizing message is received, the deviation is already near zero. Parameters "AAIntv" and "AvDrft" will show the adapted correction time interval of this ±1 ms auto-adjust function.

Time drift correction without external sync

If any external synchronizing source is not available and the system clock has a known steady drift, it is possible to roughly correct the clock deviation by editing the parameters "AAIntv" and "AvDrft". The following equation can be used if the previous "AAIntv" value has been zero.

$$AAIntv = \frac{604.8}{DriftInOneWeek}$$

If the auto-adjust interval "AAIntv" has not been zero, but further trimming is still needed, the following equation can be used to calculate a new auto-adjust interval.

$$AAIntv_{NEW} = \frac{1}{\frac{1}{AAIntv_{PREVIOUS}} + \frac{DriftInOneWeek}{604.8}}$$

The term $DriftInOneWeek/604.8$ may be replaced with the relative drift multiplied by 1000, if some other period than one week has been

used. For example if the drift has been 37 seconds in 14 days, the relative drift is $37 \cdot 1000 / (14 \cdot 24 \cdot 3600) = 0.0306$ ms/s.

Example 1

If there has been no external sync and the relay's clock is leading sixty-one seconds a week and the parameter *AAIntv* has been zero, the parameters are set as

$$AvDrft = Lead$$

$$AAIntv = \frac{604.8}{61} = 9.9s$$

With these parameter values the system clock corrects itself with -1 ms every 9.9 seconds which equals -61.091 s/week.

Example 2

If there is no external sync and the relay's clock has been lagging five seconds in nine days and the *AAIntv* has been 9.9 s, leading, then the parameters are set as

$$AAIntv_{NEW} = \frac{1}{\frac{1}{9.9} - \frac{5000}{9 \cdot 24 \cdot 3600}} = 10.6$$

$$AvDrft = Lead$$

When the internal time is roughly correct – deviation is less than four seconds – any synchronizing or auto-adjust will never turn the clock backwards. Instead, in case the clock is leading, it is softly slowed down to maintain causality.

Table 6.8: System clock parameters

Parameter	Value	Unit	Description	Note
Date			Current date	Set
Time			Current time	Set
Style			Date format	Set
	y-d-m		Year-Month-Day	
	d.m.y		Day.Month.Year	
	m/d/y		Month/Day/Year	
SyncDI	-		DI not used for synchronizing	***)
	DI1 – DI6		Minute pulse input	
TZone	-15.00 – +15.00 *)		UTC time zone for SNTP synchronization. Note: This is a decimal number. For example for state of Nepal the time zone 5:45 is given as 5.75	Set
DST	No; Yes		Daylight saving time for SNTP	Set
SySrc			Clock synchronisation source	
	Internal		No sync recognized since 200s	
	DI		Digital input	
	SNTP		Protocol sync	
	SpaBus		Protocol sync	
	ModBus		Protocol sync	
	ModBus TCP		Protocol sync	
	ProfibusDP		Protocol sync	
	IEC101		Protocol sync	
	IEC103		Protocol sync	
	DNP3		Protocol sync	
IRIG-B003		IRIG timecode B003 ****)		
MsgCnt	0 – 65535, 0 – etc.		The number of received synchronisation messages or pulses	
Dev	±32767	ms	Latest time deviation between the system clock and the received synchronization	
SyOS	±10000.000	s	Synchronisation correction for any constant deviation in the synchronizing source	Set
AAIntv	±1000	s	Adapted auto adjust interval for 1 ms correction	Set**)
AvDrft	Lead; Lag		Adapted average clock drift sign	Set**)
FilDev	±125	ms	Filtered synchronisation deviation	

Set = An editable parameter (password needed).

*) A range of -11 h – +12 h would cover the whole Earth but because the International Date Line does not follow the 180° meridian, a more wide range is needed.

***) If external synchronization is used this parameter will be set automatically.

****) Set the DI delay to its minimum and the polarity such that the leading edge is the synchronizing edge.

*****) Relay needs to be equipped with suitable hardware option module to receive IRIG-B clock synchronization signal. (Chapter 14 Order information).

Synchronisation with DI

Clock can be synchronized by reading minute pulses from digital inputs, virtual inputs or virtual outputs. Sync source is selected with **SyncDI** setting. When rising edge is detected from the selected input, system clock is adjusted to the nearest minute. Length of digital input pulse should be at least 50 ms. Delay of the selected digital input should be set to zero.

Synchronisation correction

If the sync source has a known offset delay, it can be compensated with **SyOS** setting. This is useful for compensating hardware delays or transfer delays of communication protocols. A positive value will compensate a lagging external sync and communication delays. A negative value will compensate any leading offset of the external sync source.

Sync source

When the device receives new sync message, the sync source display is updated. If no new sync messages are received within next 1.5 minutes, the device will change to internal sync mode.

Sync source: IRIG-B003

IRIG-B003 synchronization is supported with a dedicated communication option with either a two-pole or two pins in a D9 rear connector (See Chapter 14 Order information).

IRIG-B003 input clock signal voltage level is TLL. The input clock signal originated in the GPS receiver must be taken to multiple relays through an IRIG-B distribution module. This module acts as a centralized unit for a point-to-multiple point connection. Note: Daisy chain connection of IRIG-B signal inputs in multiple relays must be avoided.

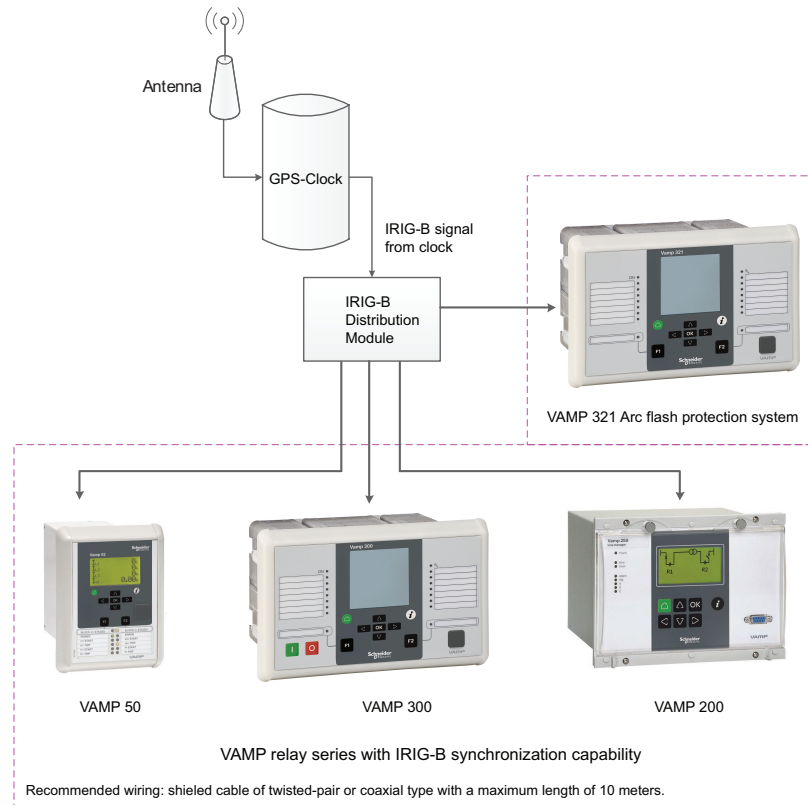

The recommended cable must be shielded and either of coaxial or twisted pair type. Its length should not exceed a maximum of 10 meters.

Deviation

The time deviation means how much system clock time differs from sync source time. Time deviation is calculated after receiving new sync message. The filtered deviation means how much the system clock was really adjusted. Filtering takes care of small deviation in sync messages.

Auto-lag/lead

The device synchronizes to the sync source, meaning it starts automatically leading or lagging to stay in perfect sync with the master. The learning process takes few days.

6.6 Running hour counter

This function calculates the total active time of the selected digital input, virtual I/O or output matrix output signal. The resolution is ten seconds.

Table 6.9: Running hour counter parameters

Parameter	Value	Unit	Description	Note
Runh	0 – 876000	h	Total active time, hours Note: The label text "Runh" can be edited with VAMPSET.	(Set)
Runs	0 – 3599	s	Total active time, seconds	(Set)
Starts	0 – 65535		Activation counter	(Set)
Status	Stop Run		Current status of the selected digital signal	
DI	- DI1 – DI6, VI1 – VI4, LedAI, LedTr, LedA, LedB, LedC, LedDR, VO1 – VO6		Select the supervised signal None Physical inputs Virtual inputs Output matrix out signal AI Output matrix out signal Tr Output matrix out signal LA Output matrix out signal LB Output matrix out signal LC Output matrix out signal DR Virtual outputs	Set
Started at			Date and time of the last activation	
Stopped at			Date and time of the last inactivation	

Set = An editable parameter (password needed).

(Set) = An informative value which can be edited as well.

6.7 Timers

The VAMP protection platform includes four settable timers that can be used together with the user's programmable logic or to control setting groups and other applications that require actions based on calendar time. Each timer has its own settings. The selected on-time and off-time is set and then the activation of the timer can be set to be as daily or according the day of week (See the setting parameters for details). The timer outputs are available for logic functions and for the block and output matrix.

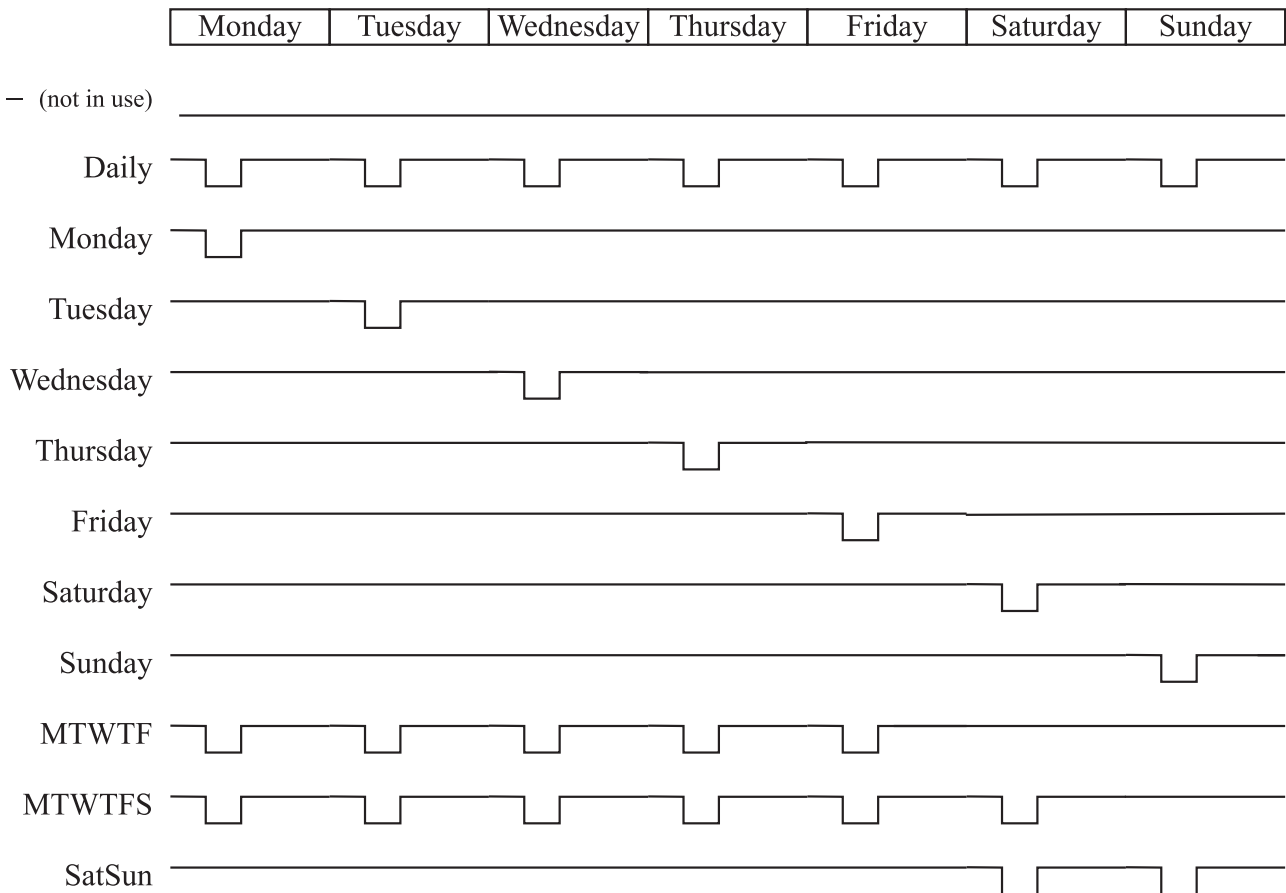

Figure 6.2: Timer output sequence in different modes.

The user can force any timer, which is in use, on or off. The forcing is done by writing a new status value. No forcing flag is needed as in forcing i.e. the output relays.

The forced time is valid until the next forcing or until the next reversing timed act from the timer itself.

The status of each timer is stored in non-volatile memory when the auxiliary power is switched off. At start up, the status of each timer is recovered.

Table 6.10: Setting parameters of timers

Parameter	Value	Description
TimerN		Timer status
	-	Not in use
	0	Output is inactive
	1	Output is active
On	hh:mm:ss	Activation time of the timer
Off	hh:mm:ss	De-activation time of the timer
Mode		For each four timers there are 12 different modes available:
	-	The timer is off and not running. The output is off i.e. 0 all the time.
	Daily	The timer switches on and off once every day.
	Monday	The timer switches on and off every Monday.
	Tuesday	The timer switches on and off every Tuesday.
	Wednesday	The timer switches on and off every Wednesday.
	Thursday	The timer switches on and off every Thursday.
	Friday	The timer switches on and off every Friday.
	Saturday	The timer switches on and off every Saturday.
	Sunday	The timer switches on and off every Sunday.
	MTWTF	The timer switches on and off every day except Saturdays and Sundays
	MTWTFS	The timer switches on and off every day except Sundays.
	SatSun	The timer switches on and off every Saturday and Sunday.

6.8 Combined overcurrent status

This function is collecting faults, fault types and registered fault currents of all enabled overcurrent stages.

Table 6.11: Line fault parameters

Parameter	Value	Unit	Description	Note
IFitLas		xIn	Current of the latest overcurrent fault	(Set)
LINE ALARM				
AlrL1			Start (=alarm) status for each phase.	
AlrL2	0		0 = No start since alarm ClrDly	
AlrL3	1		1 = Start is on	
OCs	0 1		Combined overcurrent start status. AlrL1 = AlrL2 = AlrL3 = 0 AlrL1 = 1 or AlrL2 = 1 or AlrL3 = 1	
LxAlarm	On / Off		'On' Event enabling for AlrL1 – 3 Events are enabled / Events are disabled	Set
LxAlarmOff	On / Off		'Off' Event enabling for AlrL1 – 3 Events are enabled / Events are disabled	Set
OCAAlarm	On / Off		'On' Event enabling for combined o/c starts Events are enabled / Events are disabled	Set
OCAAlarmOff	On / Off		'Off' Event enabling for combined o/c starts Events are enabled / Events are disabled	Set
IncFitEvtnt	On Off		Disabling several start <u>and</u> trip events of the same fault Several events are enabled *) Several events of an increasing fault is disabled **)	Set
ClrDly	0 – 65535	s	Duration for active alarm status AlrL1, Alr2, AlrL3 and OCs	Set
LINE FAULT				
FitL1			Fault (=trip) status for each phase.	
FitL2	0		0 = No fault since fault ClrDly	
FitL3	1		1 = Fault is on	
OCT	0 1		Combined overcurrent trip status. FitL1 = FitL2 = FitL3 = 0 FitL1 = 1 or FitL2 = 1 or FitL3 = 1	
LxTrip	On / Off		'On' Event enabling for FitL1 – 3 Events are enabled / Events are disabled	Set
LxTripOff	On / Off		'Off' Event enabling for FitL1 – 3 Events are enabled / Events are disabled	Set
OCTrip	On / Off		'On' Event enabling for combined o/c trips Events are enabled / Events are disabled	Set

Parameter	Value	Unit	Description	Note
OCTripOff	On / Off		'Off' Event enabling for combined o/c starts Events are enabled / Events are disabled	Set
IncFltEvnt	On Off		Disabling several events of the same fault Several events are enabled *) Several events of an increasing fault is disabled **)	Set
ClrDly	0 – 65535	s	Duration for active alarm status FltL1, Flt2, FltL3 and OCt	Set

Set = An editable parameter (password needed).

*) Used with IEC 60870-105-103 communication protocol. The alarm screen will show the latest if it's the biggest registered fault current, too. Not used with Spabus, because Spabus masters usually don't like to have unpaired On/Off events.

***) Used with SPA-bus protocol, because most SPA-bus masters do need an off-event for each corresponding on-event.

6.9 Self-supervision

The functions of the microcontroller and the associated circuitry, as well as the program execution are supervised by means of a separate watchdog circuit. Besides supervising the relay, the watchdog circuit attempts to restart the micro controller in an inoperable situation. If the micro controller does not resart, the watchdog issues a self-supervision signal indicating a permanent internal condition.

When the watchdog circuit detects a permanent fault, it always blocks any control of other output relays (except for the self-supervision output relay). In addition, the internal supply voltages are supervised. Should the auxiliary supply of the IED disappear, an indication is automatically given because the IED status inoperative (SF) output relay functions on a working current principle. This means that the SF relay is energized when the auxiliary supply is on and the arc flash protection is healthy.

6.9.1 Diagnostics

The device runs self-diagnostic tests for hardware and software in boot sequence and also performs runtime checking.

Permanent inoperative state

If permanent inoperative state has been detected, the device releases SF relay contact and status LED is set on. Local panel will also display a detected fault message. Permanet inoperative state is entered when the device is not able to handle main functions.

Temporal inoperative state

When self-diagnostic function detects a temporal inoperative state, Selfdiag matrix signal is set and an event (E56) is generated. In case the inoperative state was only temporary, an off event is generated (E57). Self diagnostic state can be reset via local HMI.

Diagnostic registers

There are four 16-bit diagnostic registers which are readable through remote protocols. The following table shows the meaning of each diagnostic register and their bits.

Register	Bit	Code	Description
SelfDiag1	0 (LSB)	T1	Potential output relay problem
	1	T2	
	4	A1	
	5	A2	
	6	A3	
	7	A4	
	8	A5	
SelfDiag3	0 (LSB)	DAC	Potential mA-output problem
	1	STACK	Potential stack problem
	2	MemChk	Potential memory problem
	3	BGTask	Potential background task timeout
	4	DI	Potential input problem (Remove DI1, DI2)
	5		
	6	Arc	Potential arc card problem
	7	SecPulse	Potential hardware problem
	8	RangeChk	DB: Setting outside range
	9	CPULoad	Overload
	10	+24V	Potential internal voltage problem
	11	-15V	
	12	ITemp	Internal temperature too high
	13	ADChk1	Potential A/D converter problem
	14	ADChk2	Potential A/D converter problem
15 (MSB)	E2prom	Potential E2prom problem	
SelfDiag4	1	ComBuff	Potential BUS: buffer problem

The code is displayed in self diagnostic events and on the diagnostic menu on local panel and VAMPSET.

7 Measurement functions

All the direct measurements are based on fundamental frequency values. The exceptions are frequency and instantaneous current for arc protection.

The figure shows a current waveform and the corresponding fundamental frequency component f_1 , second harmonic f_2 and rms value in a special case, when the current deviates significantly from a pure sine wave.

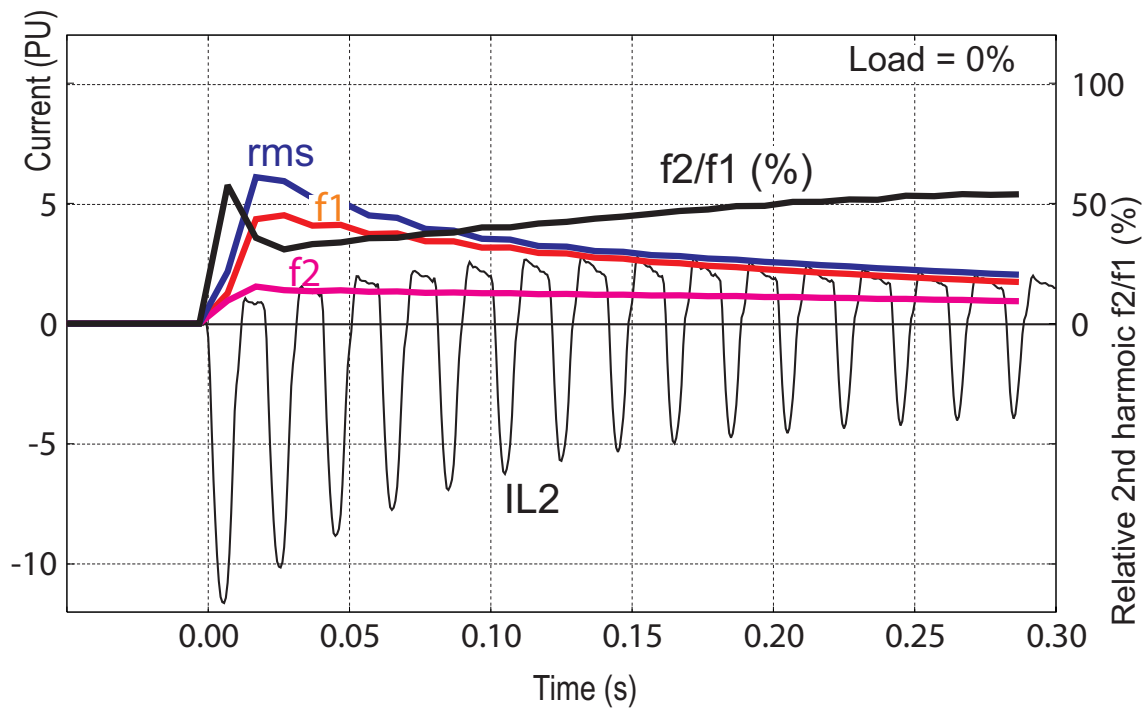

Figure 7.1: Example of various current values of a transformer inrush current

7.1 Measurement accuracy

Table 7.1: Phase current inputs I_{L1} , I_{L2} , I_{L3} , I'_{L1} , I'_{L2} , I'_{L3}

Measuring range	25mA – 250 A (5A) 5mA – 50 A (1A)
Inaccuracy:	
$I \leq 7.5$ A	± 0.5 % of value or ± 15 mA
$I > 7.5$ A	± 3 % of value
The specified frequency range is 45 Hz – 65 Hz.	
Squelch limit:	
Phase current inputs: 0.5% of I_{NOM} (tolerance $\pm 0.05\%$)	
Residual current: 0.2% of I_{0NOM} (tolerance $\pm 0.05\%$)	

Table 7.2: Residual current inputs I_{01} , I_{02}

Measuring range	0 – 5 x I_{0N}
Inaccuracy:	
$I \leq 1.5$ x I_N	± 0.3 % of value or ± 0.2 % of I_{0N}
$I > 1.5$ x I_N	± 3 % of value
The rated input I_{0N} is 5A or 1A. This must be specified when ordering the relay.	
The specified frequency range is 45 Hz – 65 Hz.	

Table 7.3: Frequency

Measuring range	16 Hz – 75 Hz
Inaccuracy	± 10 mHz
The frequency is measured from current signals.	

Table 7.4: THD and harmonics

Inaccuracy $I > 0.1$ PU	± 2 % units
Update rate	Once a second
The specified frequency range is 45 Hz – 65 Hz.	

7.2 RMS values

RMS currents

The device calculates the RMS value of each phase current. The minimum and the maximum of RMS values are recorded and stored (see Chapter 7.5 Minimum and maximum values).

$$I_{RMS} = \sqrt{I_{f1}^2 + I_{f2}^2 + \dots + I_{f15}^2}$$

7.3 Harmonics and Total Harmonic Distortion (THD)

The device calculates the THDs as a percentage of the currents and voltages values measured at the fundamental frequency. The device calculates the harmonics from the 2nd to the 15th of phase currents and voltages. (The 17th harmonic component will also be shown partly in the value of the 15th harmonic component. This is due to the nature of digital sampling.)

The harmonic distortion is calculated

$$THD = \frac{\sqrt{\sum_{i=2}^{15} h_i^2}}{h_1}$$

$h_1 =$ Fundamental value

$h_{2-15} =$ Harmonics

Example

$h_1 = 100 \text{ A}$, $h_3 = 10 \text{ A}$, $h_7 = 3 \text{ A}$, $h_{11} = 8 \text{ A}$

$$THD = \frac{\sqrt{10^2 + 3^2 + 8^2}}{100} = 13.2\%$$

For reference the RMS value is

$$RMS = \sqrt{100^2 + 10^2 + 3^2 + 8^2} = 100.9 \text{ A}$$

Another way to calculate THD is to use the RMS value as reference instead of the fundamental frequency value. In the example above the result would then be 13.0 %.

7.4 Demand values

The relay calculates average, i.e. demand values of phase currents I_{L1} , I_{L2} , I_{L3} .

The demand time is configurable from 10 minutes to 30 minutes with parameter "Demand time".

Table 7.5: Demand value parameters

Parameter	Value	Unit	Description	Set
Time	10 – 30	min	Demand time (averaging time)	Set
Fundamental frequency values				
IL1da		A	Demand of phase current IL1	
IL2da		A	Demand of phase current IL2	
IL3da		A	Demand of phase current IL3	
RMS values				
IL1da		A	Demand of phase current IL1	
IL2da		A	Demand of phase current IL2	
IL3da		A	Demand of phase current IL3	

Set = An editable parameter (password needed).

7.5 Minimum and maximum values

Minimum and maximum values are registered with time stamps since the latest manual clearing or since the device has been restarted. The available registered min & max values are listed in the following table.

Min & Max measurement	Description
IL1, IL2, IL3	Phase current (fundamental frequency value)
IL1RMS, IL2RMS, IL3RMS	Phase current, rms value
I_{01} , I_{02}	Residual current
f	Frequency
IL1da, IL2da, IL3da	Demand values of phase currents
IL1da, IL2da, IL3da (rms value)	Demand values of phase currents, rms values

The clearing parameter "ClrMax" is common for all these values.

Table 7.6: Parameters

Parameter	Value	Description	Set
ClrMax	- Clear	Reset all minimum and maximum values	Set

Set = An editable parameter (password needed).

7.6 Maximum values of the last 31 days and 12 months

Maximum and minimum values of the last 31 days and the last twelve months are stored in the non-volatile memory of the relay. Corresponding time stamps are stored for the last 31 days. The registered values are listed in the following table.

Measurement	Max	Min	Description	31 days	12 months
IL1, IL2, IL3	X		Phase current (fundamental frequency value)		
Io1, Io2	X		Residual current		

The value can be a one cycle value or an average based on the "Timebase" parameter.

Table 7.7: Parameters of the day and month registers

Parameter	Value	Description	Set
Timebase		Parameter to select the type of the registered values	Set
	20 ms	Collect min & max of one cycle values *	
	200 ms	Collect min & max of 200 ms average values	
	1 s	Collect min & max of 1 s average values	
	1 min	Collect min & max of 1 minute average values	
	demand	Collect min & max of demand values (Chapter 7.4 Demand values)	
ResetDays		Reset the 31 day registers	Set
ResetMon		Reset the 12 month registers	Set

Set = An editable parameter (password needed).

* This is the fundamental frequency rms value of one cycle updated every 20 ms.

7.7 Primary secondary and per unit scaling

Many measurement values are shown as primary values although the relay is connected to secondary signals. Some measurement values are shown as relative values - per unit or per cent. Almost all pick-up setting values are using relative scaling.

The scaling is done using the given CT and transformer / generator name plate values.

The following scaling equations are useful when doing secondary testing.

7.7.1 Current scaling

NOTE: The rated value of the device's current input, for example 5 A or 1A, does not have any effect in the scaling equations, but it defines the measurement range and the maximum allowed continuous current. See Table 12.1 for details.

Primary and secondary scaling

	Current scaling
secondary → primary	$I_{PRI} = I_{SEC} \cdot \frac{CT_{PRI}}{CT_{SEC}}$
primary → secondary	$I_{SEC} = I_{PRI} \cdot \frac{CT_{SEC}}{CT_{PRI}}$

For residual current to input I_{01} or I_{02} use the corresponding CT_{PRI} and CT_{SEC} values. For ground fault stages using I_{0Calc} signals use the phase current CT values for CT_{PRI} and CT_{SEC} .

Examples:

1. Secondary to primary

$$CT = 500 / 5$$

Current to the relay's input is 4 A.

$$\Rightarrow \text{Primary current is } I_{PRI} = 4 \times 500 / 5 = 400 \text{ A}$$

2. Primary to secondary

$$CT = 500 / 5$$

The relay displays $I_{PRI} = 400 \text{ A}$

$$\Rightarrow \text{Injected current is } I_{SEC} = 400 \times 5 / 500 = 4 \text{ A}$$

Per unit [pu] scaling

For phase currents excluding Arcl> stage:

$$1 \text{ pu} = 1 \times I_N = 100 \%, \text{ where}$$

I_N is the rated current of the transformer.

The rated current for high voltage side (HV) and low voltages side (LV) are calculated by the device itself using Equation 7.1.

Equation 7.1:

$$I_N = \frac{S_N}{\sqrt{3} \cdot U_N}$$

I_N = The rated current 1 pu.

S_N = Rated apparent power of the protected device

U_N = Rated line-to-line voltage of the protected device

For residual currents and Arcl> stage:

1 pu = 1 x CT_{SEC} for secondary side and 1 pu = 1 x CT_{PRI} for primary side.

	Phase current scaling excluding Arcl> stage	Residual current (3I ₀) scaling and phase current scaling for Arcl> stage
secondary → per unit	$I_{PU} = \frac{I_{SEC} \cdot CT_{PRI}}{CT_{SEC} \cdot I_N}$	$I_{PU} = \frac{I_{SEC}}{CT_{SEC}}$
per unit → secondary	$I_{SEC} = I_{PU} \cdot CT_{SEC} \cdot \frac{I_N}{CT_{PRI}}$	$I_{SEC} = I_{PU} \cdot CT_{SEC}$

Examples:

1. **Secondary to per unit and percent for phase currents excluding Arcl>.**

$$CT_{PRI} = 150 / 1$$

$$CT_{SEC} = 800 / 5$$

$$S_N = 25 \text{ MVA}$$

$$U_N = 110 \text{ kV}$$

$$U'_N = 21 \text{ kV}$$

Current injected to the relay's primary side input is 175 mA and 859 mA for the secondary side input.

The rated current on HV and LV side will be

$$I_N = 25 \text{ MVA} / (\sqrt{3} \times 110 \text{ kV}) = 131.2 \text{ A}$$

$$I'_N = 25 \text{ MVA} / (\sqrt{3} \times 21 \text{ kV}) = 687.3 \text{ A}$$

Per unit currents are

$$I_{PU} = 0.175 \times 150 / (1 \times 131.2) = 0.20 \text{ pu} = 20 \% \times I_N \text{ (HV side)}$$

$$I'_{PU} = 0.859 \times 800 / (5 \times 687.3) = 0.20 \text{ pu} = 20 \% \text{ (LV side)}$$

2. **Secondary to per unit for Arcl>.**

$$CT = 750 / 5$$

Current injected to the relay's inputs is 7 A.

$$\text{Per unit current is } I_{PU} = 7 / 5 = 1.4 \text{ pu} = 140 \%$$

3. **Per unit and percent to secondary for phase currents excluding Arcl>.**

$$CT_{PRI} = 150 / 1$$

$$CT_{SEC} = 800 / 5$$

$$S_N = 25 \text{ MVA}$$

$$U_N = 110 \text{ kV}$$

$$U'_N = 21 \text{ kV}$$

The relay setting is 0.20 pu = 20 % x I_N.

The rated current on HV and LV side will be same as in example 1.

The corresponding secondary currents are

$$I_{SEC} = 0.20 \times I_N = 0.20 \times 131.2 \times 1 / 150 = 175 \text{ mA (HV side)}$$

$$I'_{SEC} = 0.20 \times I'_N = 0.20 \times 687.3 \times 5 / 800 = 859 \text{ mA (LV side)}$$

4. **Per unit to secondary for Arcl>.**
CT = 750 / 5
The relay setting is 2 pu = 200 %.
Secondary current is $I_{SEC} = 2 \times 5 = 10$ A
5. **Secondary to per unit for residual current.**
Input is I_{01} or I_{02} .
CT₀ = 50 / 1
Current injected to the relay's input is 30 mA.
Per unit current is $I_{PU} = 0.03 / 1 = 0.03$ pu = 3 %
6. **Per unit to secondary for residual current.**
Input is I_{01} or I_{02} .
CT₀ = 50 / 1
The relay setting is 0.03 pu = 3 %.
Secondary current is $I_{SEC} = 0.03 \times 1 = 30$ mA
7. **Secondary to per unit for residual current.**
Input is I_{0Calc} .
CT = 750 / 5
Currents injected to the relay's IL1 input is 0.5 A.
IL2 = IL3 = 0.
Per unit current is $I_{PU} = 0.5 / 5 = 0.1$ pu = 10 %
8. **Per unit to secondary for residual current.**
Input is I_{0Calc} .
CT = 750 / 5
The relay setting is 0.1 pu = 10 %.
If IL2 = IL3 = 0, then secondary current to IL1 is $I_{SEC} = 0.1 \times 5 = 0.5$ A

8 Control functions

8.1 Output relays

The output relays are also called digital outputs. Any internal signal can be connected to the output relays using output matrix. An output relay can be configured as latched or non-latched. See Chapter 8.4 Output matrix for more details.

NOTE: If the device has the mA option, it is equipped with only three alarm relays from A1 to A3.

The difference between trip contacts and signal contacts is the DC breaking capacity. See Table 12.4 and Table 12.5 for details. The contacts are SPST normal open type (NO), except alarm relays A1 – A3, which have change over contacts (SPDT). Polarity of all output relays can be changed in VAMPSET or from Local display.

Table 8.1: Parameters of output relays

Parameter	Value	Unit	Description	Note
T1 – T2	0 1		Status of trip output relay	F
A1 – A5	0 1		Status of alarm output relay	F
SF	0 1		Status of the SF relay In VAMPSET, it is called as "Service status output"	F
Force	On Off		Force flag for output relay forcing for test purposes. This is a common flag for all output relays and detection stage status, too. Any forced relay(s) and this flag are automatically reset by a 5-minute timeout.	Set
REMOTE PULSES				
A1 – A5	0.00 – 99.98 or 99.99	s	Pulse length for direct output relay control via communications protocols. 99.99 s = Infinite. Release by writing "0" to the direct control parameter	Set
NAMES for OUTPUT RELAYS (editable with VAMPSET only)				
Description	String of max. 32 characters		Names for DO on VAMPSET screens. Default is "Trip relay n", or "Signal relay n"	Set

F = Editable when force flag is on. Set = An editable parameter (password needed).

8.2 Digital inputs

There are 6 digital inputs available for control purposes. The polarity - normal open (NO) / normal closed (NC) - and a delay can be configured according the application. The signals are available for the output matrix, block matrix, user's programmable logic etc.

The contacts connected to digital inputs DI1 – DI6 must be dry (potential free). These inputs use the common internal 48 Vdc wetting voltage from pin X3:1, only.

NOTE: These digital inputs must not be connected parallel with inputs of another device.

Table 8.2: Summary of digital inputs:

DI	Pins	Operating voltage	Availability
<-	X3:1	48VDC supply for DI1 – 6	
1	X3:2	Internal 48V dc	
2	X3:3		
3	X3:4		
4	X3:5		
5	X3:6		
6	X3:7		
19	X6:1 – 2	External 18 – 265 V dc 50 – 250 V ac	ARC card with 2 DIs
20	X6:3 – 4	External 18 – 265 V dc 50 – 250 V ac	ARC card with 2 DIs

Label and description texts can be edited with VAMPSET according the application. Labels are the short parameter names used on the local panel and descriptions are the longer names used by VAMPSET.

Table 8.3: Parameters of digital inputs

Parameter	Value	Unit	Description	Note
DI1 – DI6	0; 1		Status of digital input	
DI COUNTERS				
DI1 – DI6	0 – 65535		Cumulative active edge counter	(Set)
DELAYS FOR DIGITAL INPUTS				
DI1 – DI6	0.00 – 60.00	s	Definite delay for both on and off transitions	Set
CONFIGURATION DI1 – DI6				
Inverted	no		For normal open contacts (NO). Active edge is 0 -> 1	Set
	yes		For normal closed contacts (NC). Active edge is 1 -> 0	
Indication display	no		No pop-up display	Set
	yes		Indication display is activated at active DI edge	
On event	On		Active edge event enabled	Set
	Off		Active edge event disabled	
Off event	On		Inactive edge event enabled	Set
	Off		Inactive edge event disabled	
NAMES for DIGITAL INPUTS (editable with VAMPSET only)				
Label	String of max. 10 characters		Short name for DIs on the local display. Default is "DIn", n = 1 – 6	Set
Description	String of max. 32 characters		Long name for DIs. Default is "Digital input n", n = 1 – 6	Set

Set = An editable parameter (password needed).

8.3 Virtual inputs and outputs

There are four virtual inputs and six virtual outputs. The four virtual inputs acts like normal digital inputs. The state of the virtual input can be changed from display, communication bus and from VAMPSET. For example setting groups can be changed using virtual inputs.

Table 8.4: Parameters of virtual inputs

Parameter	Value	Unit	Description	Note
VI1 – VI4	0; 1		Status of virtual input	
Events	On; Off		Event enabling	Set
NAMES for VIRTUAL INPUTS (editable with VAMPSET only)				
Label	String of max. 10 characters		Short name for VIs on the local display Default is "VI n ", $n = 1 - 4$	Set
Description	String of max. 32 characters		Long name for VIs. Default is "Virtual input n ", $n = 1 - 4$	Set

Set = An editable parameter (password needed).

The six virtual outputs do act like output relays, but there are no physical contacts. Virtual outputs are shown in the output matrix and the block matrix. Virtual outputs can be used with the user's programmable logic and to change the active setting group etc.

8.4 Output matrix

By means of the output matrix, the output signals of the various protection stages, digital inputs, logic outputs and other internal signals can be connected to the output relays, front panel indicators, virtual outputs etc.

There are two LED indicators named "Alarm" and "Trip" on the front panel. Furthermore there are three general purpose LED indicators - "A", "B" and "C" - available for customer-specific indications. In addition, the triggering of the disturbance recorder (DR) and virtual outputs are configurable in the output matrix. See an example in Figure 8.1.

An output relay or indicator LED can be configured as latched or non-latched. A non-latched relay follows the controlling signal. A latched relay remains activated although the controlling signal releases.

There is a common "release latched" signal to release all the latched relays. This release signal resets all the latched output relays and indicators. The reset signal can be given via a digital input, via a keypad or through communication. Any digital input can be used for resetting. The selection of the input is done with the VAMPSET software under the menu "Release output matrix latches". Under the same menu, the "Release latches" parameter can be used for resetting.

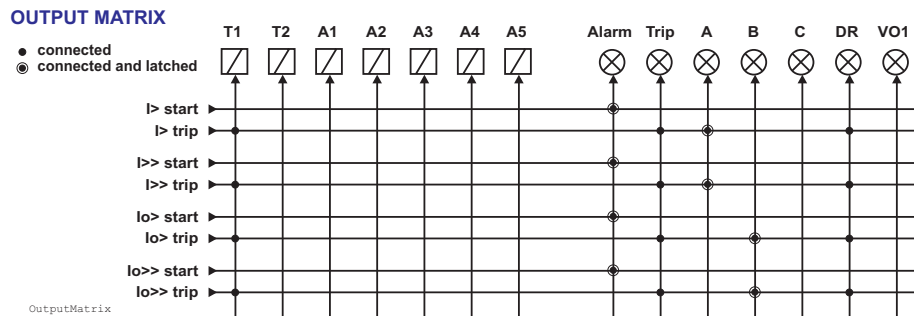

Figure 8.1: Output matrix.

8.5 Blocking matrix

By means of a blocking matrix, the operation of any protection stage can be blocked. The blocking signal can originate from the digital inputs DI1 to DI6, or it can be a start or trip signal from a protection stage or an output signal from the user's programmable logic. In the block matrix Figure 8.2 an active blocking is indicated with a black dot (•) in the crossing point of a blocking signal and the signal to be blocked.

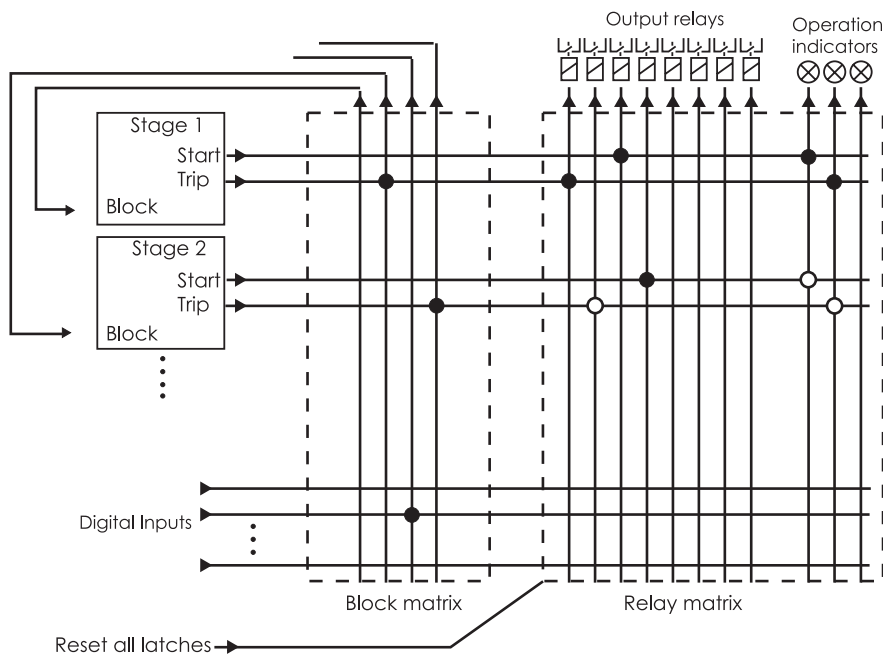

Figure 8.2: Blocking matrix and output matrix

8.6 Controllable objects

The device allows controlling of six objects, that is, circuit-breakers, disconnectors and earthing switches. Controlling can be done by "select-execute" or "direct control" principle.

The object block matrix and logic functions can be used to configure interlocking for a safe controlling before the output pulse is issued. The objects 1 – 6 are controllable while the objects 7 – 8 are only able to show the status.

Controlling is possible by the following ways:

- through the local HMI
- through a remote communication
- through a digital input

The connection of an object to specific output relays is done via an output matrix (object 1 – 6 open output, object 1 – 6 close output). There is also an output signal “Object failed”, which is activated if the control of an object is not completed.

Object states

Each object has the following states:

Setting	Value	Description
Object state	Undefined (00)	Actual state of the object
	Open	
	Close	
	Undefined (11)	

Basic settings for controllable objects

Each controllable object has the following settings:

Setting	Value	Description
DI for 'obj open'	None, any digital input, virtual input or virtual output	Open information
DI for 'obj close'		Close information
DI for 'obj ready'		Ready information
Max ctrl pulse length	0.02 – 600 s	Pulse length for open and close commands
Completion timeout	0.02 – 600 s	Timeout of ready indication
Object control	Open/Close	Direct object control

If changing states takes longer than the time defined by “Max ctrl pulse length” setting, object is inoperative and “Object failure” matrix signal is set. Also undefined-event is generated. “Completion timeout” is only used for the ready indication. If “DI for 'obj ready'” is not set, completion timeout has no meaning.

Each controllable object has 2 control signals in matrix:

Output signal	Description
Object x Open	Open control signal for the object
Object x Close	Close control signal for the object

These signals send control pulse when an object is controlled by digital input, remote bus, auto-reclose etc.

Settings for read-only objects

Setting	Value	Description
DI for 'obj open'	None, any digital input, virtual input or virtual output	Open information
DI for 'obj close'		Close information
Object timeout	0.02 – 600 s	Timeout for state changes

If changing states takes longer than the time defined by “Object timeout” setting, and “Object failure” matrix signal is set. Also undefined-event is generated.

8.6.1 Controlling with DI

Objects can be controlled with digital input, virtual input or virtual output. There are four settings for each controllable object:

Setting	Active
DI for remote open / close control	In remote state
DI for local open / close control	In local state

If the device is in local control state, the remote control inputs are ignored and vice versa. Object is controlled when a rising edge is detected from the selected input. Length of digital input pulse should be at least 60 ms.

8.6.2 Local/Remote selection

In Local mode, the output relays can be controlled via a local HMI, but they cannot be controlled via a remote serial communication interface.

In Remote mode, the output relays cannot be controlled via a local HMI, but they can be controlled via a remote serial communication interface.

The selection of the Local/Remote mode is done by using a local HMI, or via one selectable digital input. The digital input is normally used to change a whole station to a local or remote mode. The selection of the L/R digital input is done in the “Objects” menu of the VAMPSET software.

NOTE: A password is not required for a remote control operation.

8.7 Logic functions

The device supports customer-defined programmable logic for boolean signals. The logic is designed by using the VAMPSET setting tool and downloaded to the device. Functions available are:

- AND
- XOR
- COUNTERs
- OR
- NOT
- RS & D flip-flops

Logic is made with VAMPSET setting tool. Consumed memory is dynamically shown on the configuration view in percentage. The first value indicates amount of used inputs, second amount of gates and third values shows amount of outputs consumed.

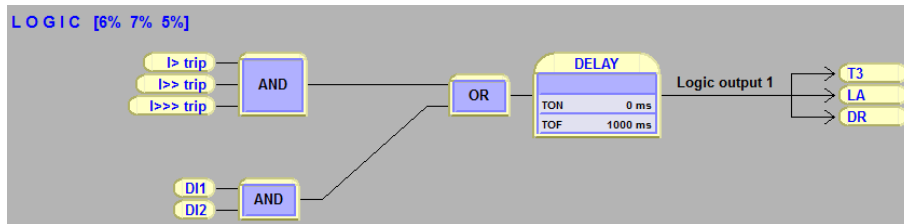

Figure 8.3: Logic can be found and modified in “logic” menu in VAMPSET setting tool

Percentages show used memory amount.

Inputs/Logical functions/Outputs- used. None of these is not allowed to exceed 100%. See guide below to learn basics of logic creation:

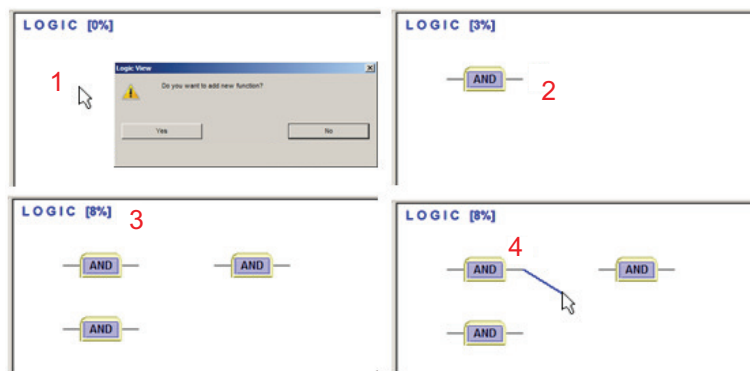

Figure 8.4: How to create logical nodes.

1. Press empty area to add a logic gate, confirm new function by pressing “Yes”.
2. Logic function is always "AND" -gate as a default.
3. While logic increases the capacity is increasing as well.
4. To joint logic functions, go on top of the output line of gate and hold down mouse left -> make the connection to other logic functions input.

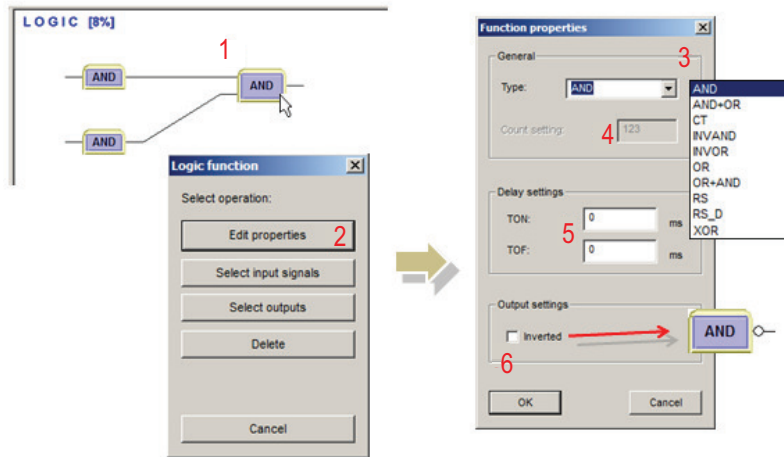

Figure 8.5: Logic creation

1. Left click on top of any logic function to activate the “Select operation” view.
2. Edit properties button opens the “Function properties” window.
3. Generally it is possible to choose the type of logic function between and/or/counter/swing -gate.
4. When counter is selected, count setting may be set here.
5. Separate delay setting for logic activation and dis-activation.
6. Possible to invert the output of logic. Inverted logic output is marked with circle.

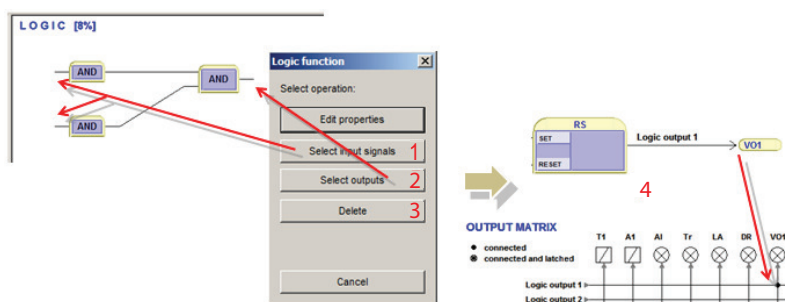

Figure 8.6: Logic creation

1. Select input signals can be done by pressing the following button or by clicking mouse left on top of the logic input line.
2. Select outputs can be done by pressing the following button or by clicking mouse left on top of the logic output line.
3. This deletes the logic function.
4. When logic is created and settings are written to the IED the unit requires a restart. After restarting the logic output is automatically assigned in output matrix as well.

NOTE: Whenever writing new logic to the IED the unit has to be restarted.

9 Communication

9.1 Communication ports

The device has three communication ports as standard. A fourth port, Ethernet, is available as option. See Figure 9.1.

There are three communication ports in the rear panel. The Ethernet port is optional. The X4 connector includes two ports: local port and extension port. The front panel RS-232 port will shut off the local port on the rear panel when a VX003 cable is inserted.

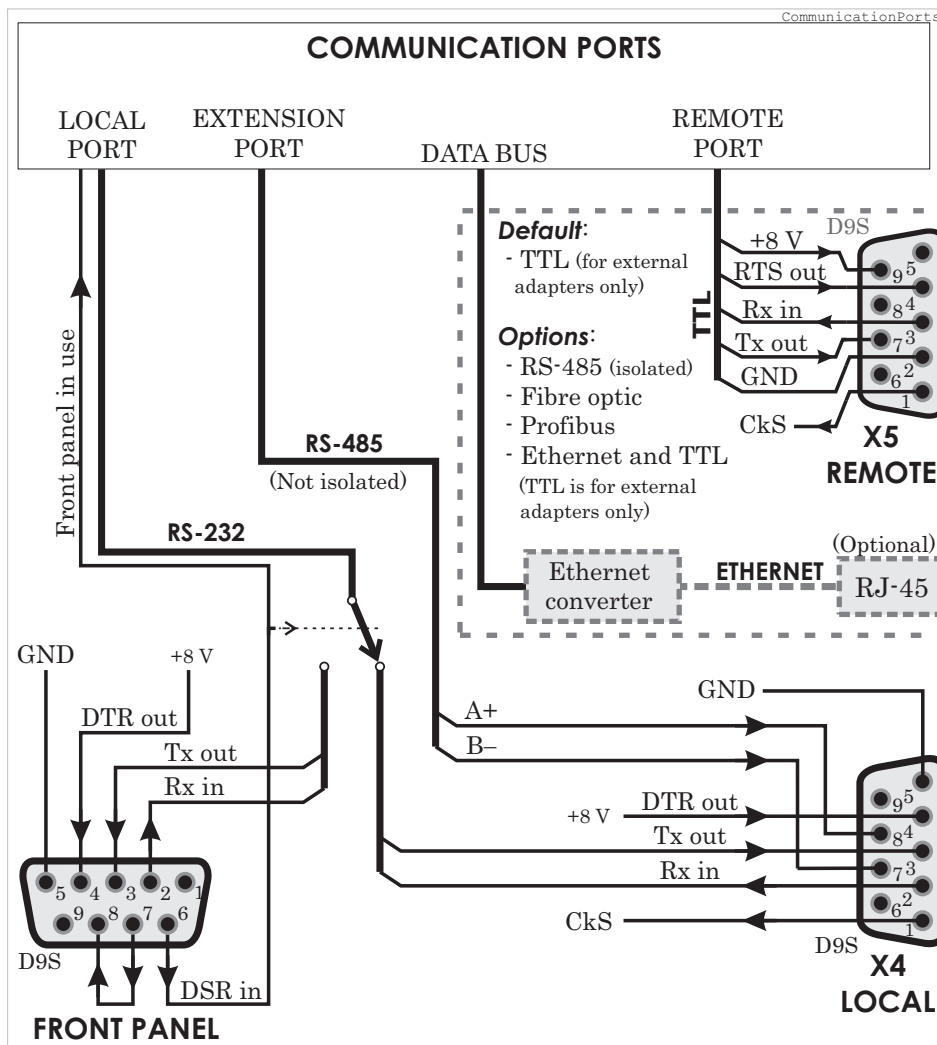

Figure 9.1: Communication ports and connectors. By default the X5 is a D9S type connector with TTL interface. The DSR signal from the front panel port selects the active connector for the RS232 local port.

By default the remote port has a TTL interface. It can only be used together with external converters or converting cables. Inbuilt options for RS-485, fibre optic (plastic/plastic, plastic/glass, glass/plastic or glass/glass), Profibus and Ethernet are available.

9.1.1 Local port X4

The local port has two connectors:

- On the front panel
- X4 the rear panel (D9S pins 2, 3 and 5)

Only one can be used at a time.

NOTE: The extension port is locating in the same X4 connector.

When the VX003 cable is inserted to the front panel connector it activates the front panel port and disables the rear panel local port by connecting the DTR pin 6 and DSR pin 4 together. See Figure 9.1.

Protocol for the local port

The front panel port is always using the command line protocol for VAMPSET regardless of the selected protocol for the rear panel local port.

If other than "None" protocol is selected for the rear panel local port, the front panel connector, when activated, is still using the plain command line interface with the original speed, parity etc. For example if the rear panel local port is used for remote VAMPSET communication using SPA-bus default 9600/7E1, it is possible to temporarily connect a PC with VAMPSET to the front panel connector with the default 38400/8N1. While the front panel connector is in use, the rear panel local port is disabled. The communication parameter display on the local display will show the active parameter values for the local port.

Physical interface

The physical interface of this port is RS-232.

Table 9.1: Parameters

Parameter	Value	Unit	Description	Note
Protocol			Protocol selection for the rear panel local port.	Set
	None		Command line interface for VAMPSET	
	SpaBus		SPA-bus (slave)	
	ProfibusDP		Profibus DB (slave)	
	ModbusSla		Modbus RTU slave	
	ModbusTCPs		Modbus TCP slave	
	IEC-103		IEC-60870-5-103 (slave)	
	ExternalIO		Modbus RTU master for external I/O-modules	
	DNP3		DNP 3.0	
Msg#	0 – 2 ³² -1		Message counter since the device has restarted or since last clearing	Clr
Errors	0 – 2 ¹⁶ -1		Protocol errors since the device has restarted or since last clearing	Clr
Tout	0 – 2 ¹⁶ -1		Timeout errors since the device has restarted or since last clearing	Clr
	speed/DPS Default = 38400/8N1 for VAMPSET		Display of actual communication parameters. Speed = bit/s D = number of data bits P = parity: none, even, odd S = number of stop bits	1)
VAMPSET communication (Direct or SPA-bus embedded command line interface)				
Tx	bytes/size		Unsent bytes in transmitter buffer/size of the buffer	
Msg#	0 – 2 ³² -1		Message counter since the device has restarted or since last clearing	Clr
Errors	0 – 2 ¹⁶ -1		Errors since the device has restarted or since last clearing	Clr
Tout	0 – 2 ¹⁶ -1		Timeout errors since the device has restarted or since last clearing	Clr

Set = An editable parameter (password needed). Clr = Clearing to zero is possible.

1) The communication parameters are set in the protocol specific menus. For the local port command line interface the parameters are set in configuration menu.

9.1.2 Remote port X5

Physical interface

The physical interface of this port depends of the communication letter in the order code. See Figure 9.1, Chapter 11.3.2 Rear panel connector X5 (REMOTE) and the table below. The TTL interface is for external converters and converter cables only. It is not suitable for direct connection to distances more than one meter.

Table 9.2: Parameters

Parameter	Value	Unit	Description	Note
Protocol			Protocol selection for remote port	Set
	None		-	
	SPA-bus		SPA-bus slave	
	ProfibusDP		Profibus DB slave	
	ModbusSla		Modbus RTU slave	
	ModbusTCPs		Modbus TCP slave	
	IEC-103		IEC-60870-5-103 slave	
	ExternalIO		Modbus RTU master for external I/O-modules	
DNP3		DNP 3.0		
Msg#	0 – 2 ³² -1		Message counter since the device has restarted or since last clearing	Clr
Errors	0 – 2 ¹⁶ -1		Protocol errors since the device has restarted or since last clearing	Clr
Tout	0 – 2 ¹⁶ -1		Timeout errors since the device has restarted or since last clearing	Clr
	speed/DPS		Display of current communication parameters. Speed = bit/s D = number of data bits P = parity: none, even, odd S = number of stop bits	1)
Debug	No		Echo to local port No echo	Set
	Binary		For binary protocols	
	ASCII		For SPA-bus protocol	

Set = An editable parameter (password needed). Clr = Clearing to zero is possible.

1) The communication parameters are set in the protocol specific menus. For the local port command line interface the parameters are set in configuration menu.

9.1.3 Extension port X4

This is a non-isolated RS-485 port for external I/O devices. The port is located in the same rear panel D9S connector X4 as the local port, but pins (7, 8, 5) are used instead of the standard RS-232 pins (2, 3, 5) used by the local port. See Figure 9.1.

Table 9.3: Parameters

Parameter	Value	Unit	Description	Note
Protocol			Protocol selection for extension port	Set
	None		Command line interface for VAMPSET	
	SPA-bus		SPA-bus slave	
	ProfibusDP		Profibus DB slave	
	ModbusSla		Modbus RTU slave	
	ModbusTCPs		Modbus TCP slave	
	IEC-103		IEC-60870-5-103 slave	
	ExternallO		Modbus RTU master for external I/O-modules	
	DNP3		DNP 3.0	
Msg#	0 – 2 ³² -1		Message counter since the device has restarted or since last clearing	Clr
Errors	0 – 2 ¹⁶ -1		Protocol errors since the device has restarted or since last clearing	Clr
Tout	0 – 2 ¹⁶ -1		Timeout errors since the device has restarted or since last clearing	Clr
	speed/DPS Default = 38400/8N1 for VAMPSET		Display of current communication parameters. Speed = bit/s D = number of data bits P = parity: none, even, odd S = number of stop bits	1)

Set = An editable parameter (password needed). Clr = Clearing to zero is possible.

1) The communication parameters are set in the protocol specific menus. For the local port command line interface the parameters are set in configuration menu.

9.1.4 Ethernet port

TCP port 1st INST and TCP port 2nd INST are ports for ethernet communication protocols. Ethernet communication protocols can be selected to these ports when such hardware option is installed. The parameters for these ports are set via local HMI or with VAMPSET in menus TCP port 1st INST and TCP port 2nd INST. Two different protocols can be used simultaneously on one physical interface (both protocols use the same IP address and MAC address but different IP port).

Protocol configuration menu contains address and other related information for the ethernet port. TCP port 1st and 2nd instance include selection for the protocol, IP port settings and message/error/timeout counters. More information about the protocol configuration menu on table below.

Table 9.4: Main configuration parameters (local display), inbuilt Ethernet port

Parameter	Value	Unit	Description	Note
Protocol			Protocol selection for the extension port	Set
	None		Command line interface for VAMPSET	
	ModbusTCPs		Modbus TCP slave	
	IEC-101		IEC-101	
	IEC 61850		IEC-61850 protocol	
	EtherNet/IP		Ethernet/IP protocol	
	DNP3		DNP/TCP	
Port	nnn		Ip port for protocol, default 102	Set
IpAddr	n.n.n.n		Internet protocol address (set with VAMPSET)	Set
NetMsk	n.n.n.n		Net mask (set with VAMPSET)	Set
Gatew	default = 0.0.0.0		Gateway IP address (set with VAMPSET)	Set
NTPSvr	n.n.n.n		Network time protocol server (set with VAMPSET) 0.0.0.0 = no SNTP	Set
KeepAlive	nn		TCP keepalive interval	Set 1)
FTP server	on/off		Enable FTP server	Set
FTP speed	4 Kb/s (default)		Maximum transmission speed for FTP	Set
FTP password	? (user) config (configurator)		FTP password	Set
MAC address	001ADnnnnnnn		MAC address	
VS Port	nn 23 (default)		IP port for Vampset	Set
Msg#	nnn		Message counter	
Errors	nnn		Error counter	
Tout	nnn		Timeout counter	

Parameter	Value	Unit	Description	Note
EthSffEn	on/off		Sniffer port enable	Set
SniffPort	Port2		Sniffer port	

Set = An editable parameter (password needed)

1) KeepAlive: The KeepAlive parameter sets in seconds the time between two keepalive packets are sent from the IED. The setting range for this parameter is between zero (0) and 20 seconds; with the exception that zero (0) means actually 120 seconds (2 minutes). A keep alive's packet purpose is for the VAMP IED to send a probe packet to a connected client for checking the status of the TCP-connection when no other packet is being sent e.g. client does not poll data from the IED. If the keepalive packet is not acknowledged, the IED will close the TCP connection. Connection must be resumed on the client side.

Table 9.5: TCP PORT 1st INST

Parameter	Value	Unit	Description	Note
Protocol			Protocol selection for the extension port.	Set
	None		Command line interface for VAMPSET	
	ModbusTCPs		Modbus TCP slave	
	IEC 61850		IEC-61850 protocol	
	EtherNet/IP		Ethernet/IP protocol	
	DNP3		DNP/TCP	
Port	nnn		Ip port for protocol, default 502	Set
Msg#	nnn		Message counter	
Errors	nnn		Error counter	
Tout	nnn		Timeout counter	

Table 9.6: CP PORT 2nd INST

Parameter	Value	Unit	Description	Note
Ethernet port protocol (TCP PORT 2nd INST)			Protocol selection for the extension port.	Set
	None		Command line interface for VAMPSET	
	ModbusTCPs		Modbus TCP slave	
	IEC 61850		IEC-61850 protocol	
	EtherNet/IP		Ethernet/IP protocol	
	DNP3		DNP/TCP	
Port	nnn		Ip port for protocol, default 502	Set
Msg#	nnn		Message counter	
Errors	nnn		Error counter	
Tout	nnn		Timeout counter	

Set = An editable parameter (password needed).

9.2 Communication protocols

The protocols enable the transfer of the following type of data:

- events
- status information
- measurements
- control commands.
- clock synchronizing
- Settings (SPA-bus and embedded SPA-bus only)

9.2.1 PC communication

PC communication is using a VAMP specified command line interface. The VAMPSET program can communicate using the local RS-232 port or using ethernet interface.

It is also possible to select SPA-bus protocol for the local port and configure the VAMPSET to embed the command line interface inside SPA-bus messages.

For Ethernet configuration, see Chapter 9.1.4 Ethernet port.

9.2.2 Modbus TCP and Modbus RTU

These Modbus protocols are often used in power plants and in industrial applications. The difference between these two protocols is the media. Modbus TCP uses Ethernet and Modbus RTU uses asynchronous communication (RS-485, optic fibre, RS-232).

VAMPSET will show the list of all available data items for Modbus.

The Modbus communication is activated usually for remote port via a menu selection with parameter "Protocol". See Chapter 9.1 Communication ports.

For Ethernet interface configuration, see Chapter 9.1.4 Ethernet port.

Table 9.7: Parameters

Parameter	Value	Unit	Description	Note
Addr	1 – 247		Modbus address for the device. Broadcast address 0 can be used for clock synchronizing. Modbus TCP uses also the TCP port settings.	Set
bit/s	1200 2400 4800 9600 19200	bps	Communication speed for Modbus RTU	Set
Parity	None Even Odd		Parity for Modbus RTU	Set

Set = An editable parameter (password needed)

9.2.3 Profibus DP

The Profibus DP protocol is widely used in industry. An inbuilt Profibus option card or external VPA 3CG is required.

Device profile "continuous mode"

In this mode, the device is sending a configured set of data parameters continuously to the Profibus DP master. The benefit of this mode is the speed and easy access to the data in the Profibus master. The drawback is the maximum buffer size of 128 bytes, which limits the number of data items transferred to the master. Some PLCs have their own limitation for the Profibus buffer size, which may further limit the number of transferred data items.

Device profile "Request mode"

Using the request mode it is possible to read all the available data from the VAMP device and still use only a very short buffer for Profibus data transfer. The drawback is the slower overall speed of the data transfer and the need of increased data processing at the Profibus master as every data item must be separately requested by the master.

NOTE: In request mode, it is not possible to read continuously only one single data item. At least two different data items must be read in turn to get updated data from the device.

There is a separate manual for VPA 3CG (VVPA3CG/EN M/xxxx) for the continuous mode and request mode. The manual is available to download from our website.

Available data

VAMPSET will show the list of all available data items for both modes. A separate document "Profibus parameters.pdf" is also available.

The Profibus DP communication is activated usually for remote port via a menu selection with parameter "Protocol". See Chapter 9.1 Communication ports.

Table 9.8: Parameters

Parameter	Value	Unit	Description	Note
Mode			Profile selection	Set
	Cont		Continuous mode	
	Reqst		Request mode	
bit/s	2400	bps	Communication speed from the main CPU to the Profibus converter. (The actual Profibus bit rate is automatically set by the Profibus master and can be up to 12 Mbit/s.)	
Emode			Event numbering style.	(Set)
	Channel		Use this for new installations.	
	(Limit60)		(The other modes are for compatibility with old systems.)	
	(NoLimit)			
InBuf		bytes	Size of Profibus master's Rx buffer. (data to the master)	1. 3.
OutBuf		bytes	Size of Profibus master's Tx buffer. (data from the master)	2. 3.
Addr	1 – 247		This address has to be unique within the Profibus network system.	Set
Conv			Converter type	4.
	-		No converter recognized	
	VE		Converter type "VE" is recognized	

Set = An editable parameter (password needed)

Clr = Clearing to zero is possible

1. In continuous mode the size depends of the biggest configured data offset of a data item to be send to the master. In request mode the size is 8 bytes.
2. In continuous mode the size depends of the biggest configured data offset of a data to be read from the master. In request mode the size is 8 bytes.
3. When configuring the Profibus master system, the lengths of these buffers are needed. The device calculates the lengths according the Profibus data and profile configuration and the values define the in/out module to be configured for the Profibus master.
4. If the value is "-", Profibus protocol has not been selected or the device has not restarted after protocol change or there is a communication problem between the main CPU and the Profibus ASIC.

9.2.4 SPA-bus

The device has full support for the SPA-bus protocol including reading and writing the setting values. Also reading of multiple consecutive status data bits, measurement values or setting values with one message is supported.

Several simultaneous instances of this protocol, using different physical ports, are possible, but the events can be read by one single instance only.

There is a separate document “Spabus parameters.pdf” of SPA-bus data items available.

Table 9.9: Parameters

Parameter	Value	Unit	Description	Note
Addr	1 – 899		SPA-bus address. Must be unique in the system.	Set
bit/s	1200 2400 4800 9600 (default) 19200	bps	Communication speed	Set
Emode			Event numbering style.	(Set)
	Channel		Use this for new installations.	
	(Limit60)		(The other modes are for compatibility with old systems.)	
	(NoLimit)			

Set = An editable parameter (password needed)

9.2.5 IEC 60870-5-103

The IEC standard 60870-5-103 "*Companion standard for the informative interface of protection equipment*" provides standardized communication interface to a primary system (master system).

The unbalanced transmission mode of the protocol is used, and the device functions as a secondary station (slave) in the communication. Data is transferred to the primary system using "data acquisition by polling"-principle

The IEC functionality includes application functions:

- station initialization
- general interrogation
- clock synchronization and
- command transmission.

It is not possible to transfer parameter data or disturbance recordings via the IEC 103 protocol interface.

The following ASDU (Application Service Data Unit) types will be used in communication from the device:

- ASDU 1: time tagged message
- ASDU 3: Measurands I
- ASDU 5: Identification message
- ASDU 6: Time synchronization and
- ASDU 8: Termination of general interrogation.

The device will accept:

- ASDU 6: Time synchronization
- ASDU 7: Initiation of general interrogation and
- ASDU 20: General command.

The data in a message frame is identified by:

- type identification
- function type and
- information number.

These are fixed for data items in the compatible range of the protocol, for example, the trip of I> function is identified by: type identification = 1, function type = 160 and information number = 90. "Private range" function types are used for such data items, which are not defined by the standard (e.g. the status of the digital inputs and the control of the objects).

The function type and information number used in private range messages is configurable. This enables flexible interfacing to different master systems.

For more information on IEC 60870-5-103 in VAMP devices refer to the “IEC103 Interoperability List” document.

Table 9.10: Parameters

Parameter	Value	Unit	Description	Note
Addr	1 – 254		An unique address within the system	Set
bit/s	9600 19200	bps	Communication speed	Set
MeasInt	200 – 10000	ms	Minimum measurement response interval	Set
SyncRe	Sync Sync+Proc Msg Msg+Proc		ASDU6 response time mode	Set

Set = An editable parameter (password needed)

Table 9.11: Parameters for disturbance record reading

Parameter	Value	Unit	Description	Note
ASDU23	On Off		Enable record info message	Set
SmpIs/msg	1 – 25		Record samples in one message	Set
Timeout	10 – 10000	s	Record reading timeout	Set
Fault			Fault identifier number for IEC-103. Starts + trips of all stages.	
TagPos			Position of read pointer	
Chn			Active channel	
ChnPos			Channel read position	
Fault numbering				
Faults			Total number of faults	
GridFlts			Fault burst identifier number	
Grid			Time window to classify faults together to the same burst.	Set

Set = An editable parameter (password needed)

9.2.6 DNP 3.0

The relay supports communication using DNP 3.0 protocol. The following DNP 3.0 data types are supported:

- binary input
- binary input change
- double-bit input
- binary output
- analog input
- counters

Additional information can be obtained from the “DNP 3.0 Device Profile Document” and “DNP 3.0 Parameters.pdf”. DNP 3.0 communication is activated via menu selection. RS-485 interface is often used but also RS-232 and fibre optic interfaces are possible.

Table 9.12: Parameters

Parameter	Value	Unit	Description	Set
bit/s	4800 9600 (default) 19200 38400	bps	Communication speed	Set
Parity	None (default) Even Odd		Parity	Set
SlvAddr	1 – 65519		An unique address for the device within the system	Set
MstrAddr	1 – 65519 255 = default		Address of master	Set
LLTout	0 – 65535	ms	Link layer confirmation timeout	Set
LLRetry	1 – 255 1 = default		Link layer retry count	Set
APLTout	0 – 65535 5000 = default	ms	Application layer confirmation timeout	Set
CnfMode	EvOnly (default); All		Application layer confirmation mode	Set
DBISup	No (default); Yes		Double-bit input support	Set
SyncMode	0 – 65535	s	Clock synchronization request interval. 0 = only at boot	Set

Set = An editable parameter (password needed)

9.2.7 IEC 60870-5-101

The IEC 60870-5-101 standard is derived from the IEC 60870-5 protocol standard definition. In VAMP devices, IEC 60870-5-101 communication protocol is available via menu selection. The VAMP unit works as a controlled outstation (slave) unit in unbalanced mode.

Supported application functions include process data transmission, event transmission, command transmission, general interrogation, clock synchronization, transmission of integrated totals, and acquisition of transmission delay.

For more information on IEC 60870-5-101 in VAMP devices, refer to the “IEC 101 Profile checklist & datalist.pdf” document.

Table 9.13: Parameters

Parameter	Value	Unit	Description	Note
bit/s	1200	bps	Bitrate used for serial communication.	Set
	2400			
	4800			
	9600			
Parity	None		Parity used for serial communication	Set
	Even			
	Odd			
LLAddr	1 – 65534		Link layer address	Set
LLAddrSize	1 – 2	Bytes	Size of Link layer address	Set
ALAddr	1 – 65534		ASDU address	Set
ALAddrSize	1 – 2	Bytes	Size of ASDU address	Set
IOAddrSize	2 – 3	Bytes	Information object address size. (3-octet addresses are created from 2-octet addresses by adding MSB with value 0.)	Set
COTsize	1	Bytes	Cause of transmission size	
TTFormat	Short		The parameter determines time tag format: 3-octet time tag or 7-octet time tag.	Set
	Full			
MeasFormat	Scaled		The parameter determines measurement data format: normalized value or scaled value.	Set
	Normalized			
DbandEna	No		Dead-band calculation enable flag	Set
	Yes			
DbandCy	100 – 10000	ms	Dead-band calculation interval	Set

Set = An editable parameter (password needed)

9.2.8 External I/O (Modbus RTU master)

External Modbus I/O devices can be connected to the relay using this protocol. (See Chapter 11.6.2 Third-party external input / output modules module for more information).

9.2.9 IEC 61850

The relay supports communication using IEC 61850 protocol with native implementation. IEC 61850 protocol is available with the optional inbuilt Ethernet port. The protocol can be used to read / write static data from the relay or to receive events and to receive / send GOOSE messages to other relays.

IEC 61850 server interface is capable of

- Configurable data model: selection of logical nodes corresponding to active application functions
- Configurable pre-defined data sets
- Supported dynamic data sets created by clients
- Supported reporting function with buffered and unbuffered Report Control Blocks
- Sending analogue values over GOOSE
- Supported control modes:
 - direct with normal security
 - direct with enhanced security
 - select before operation with normal security
 - select before operation with enhanced security
- Supported horizontal communication with GOOSE: configurable GOOSE publisher data sets, configurable filters for GOOSE subscriber inputs, GOOSE inputs available in the application logic matrix

Additional information can be obtained from the separate documents “IEC 61850 conformance statement.pdf”, “IEC 61850 Protocol data.pdf” and “Configuration of IEC 61850 interface.pdf”.

9.2.10 EtherNet/IP

The device supports communication using EtherNet/IP protocol which is a part of CIP (Common Industrial Protocol) family. EtherNet/IP protocol is available with the optional inbuilt Ethernet port. The protocol can be used to read / write data from the device using request / response communication or via cyclic messages transporting data assigned to assemblies (sets of data).

For more detailed information and parameter lists for EtherNet/IP, refer to a separate application note “Application Note EtherNet/IP.pdf”.

For the complete data model of EtherNet/IP, refer to the document “Application Note DeviceNet and EtherNetIP Data Model.pdf”.

9.2.11 FTP server

The FTP server is available on VAMP IEDs equipped with an inbuilt or optional Ethernet card.

The server enables downloading of the following files from an IED:

- Disturbance recordings.
- The MasterICD and MasterICDEd2 files.

The MasterICD and MasterICDEd2 files are VAMP-specific reference files that can be used for offline IEC61850 configuration.

The inbuilt FTP client in Microsoft Windows or any other compatible FTP client may be used to download files from the device.

Parameter	Value	Unit	Description	Note
Enable FTP server	Yes No		Enable or disable the FTP server.	Set
FTP password	Max 33 characters		Required to access the FTP server with an FTP client. Default is “config”. The user name is always “vamp”.	Set
FTP max speed	1 – 10	KB/s	The maximum speed at which the FTP server will transfer data.	Set

9.2.12

DeviceNet

The device supports communication using DeviceNet protocol which is a part of CIP (Common Industrial Protocol) family. DeviceNet protocol is available with the optional external VSE009 module. The protocol can be used to read / write data from the device using request / response communication or via cyclic messages transporting data assigned to assemblies (sets of data).

For more detailed information about DeviceNet, refer to a separate application note “Application Note DeviceNet.pdf”.

For the complete data model of DeviceNet, refer to the document “Application Note DeviceNet and EtherNet/IP Data Model.pdf”.

10 Applications

10.1 Restricted earth fault protection

Restricted earth fault (REF) protection is a sensitive way to protect a zone between two measuring points against earth faults. See Figure 10.1.

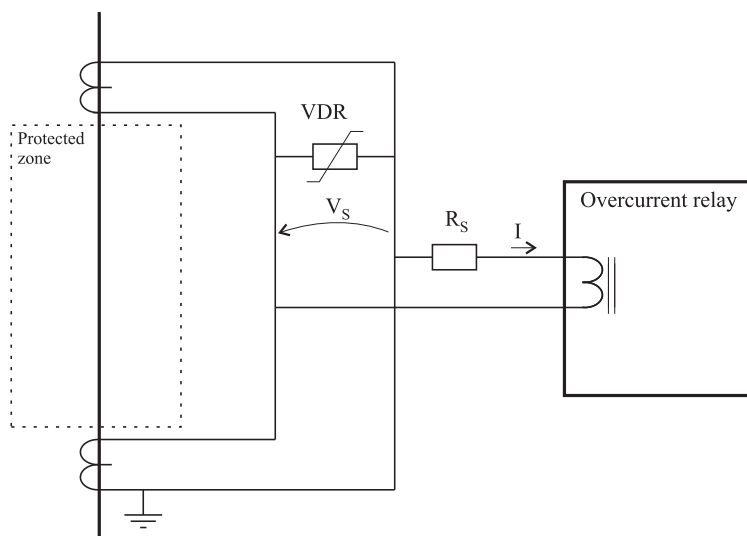

Figure 10.1: Principle of restricted earth fault protection. The CT secondaries are wired to cancel each other's currents during through faults and to drive all to the relay when the fault is inside the protected zone. (Saturation of the CTs makes the situation a little more complicated than that.) The stabilizing resistor R_S guarantees that the relay will not trip during a through fault. The VDR is used to protect the CTs and the wiring by limiting the voltage V_S during heavy inside faults.

When there is a fault outside the protected zone the CT secondaries will cancel each other's currents. This is partly true even if both or only one of the CTs saturates, because the impedance of a saturated CT secondary will collapse to near zero. The non-zero wiring impedance and CT impedance will however cause a voltage V_S , but the resistor R_S will prevent the relay from tripping. R_S is called the stabilizing resistor.

During an inside fault the secondary currents of the two CTs have no other way to go than the relay. The relay will trip when the current $I = V_S / R_S$ exceeds the setting I_S of the relay. The voltage dependent resistor (VDR, varistor, METROSIL) is used to protect the CTs and wiring by limiting the voltage V_S during heavy inside faults.

The resistance of the secondary loop connecting the CTs together should be as low as possible.

10.2 Restricted earth fault protection for a transformer with neutral connection

Figure 10.2 shows an example where three phase current CTs are connected parallel with each other and then in series with the CT in the neutral point.

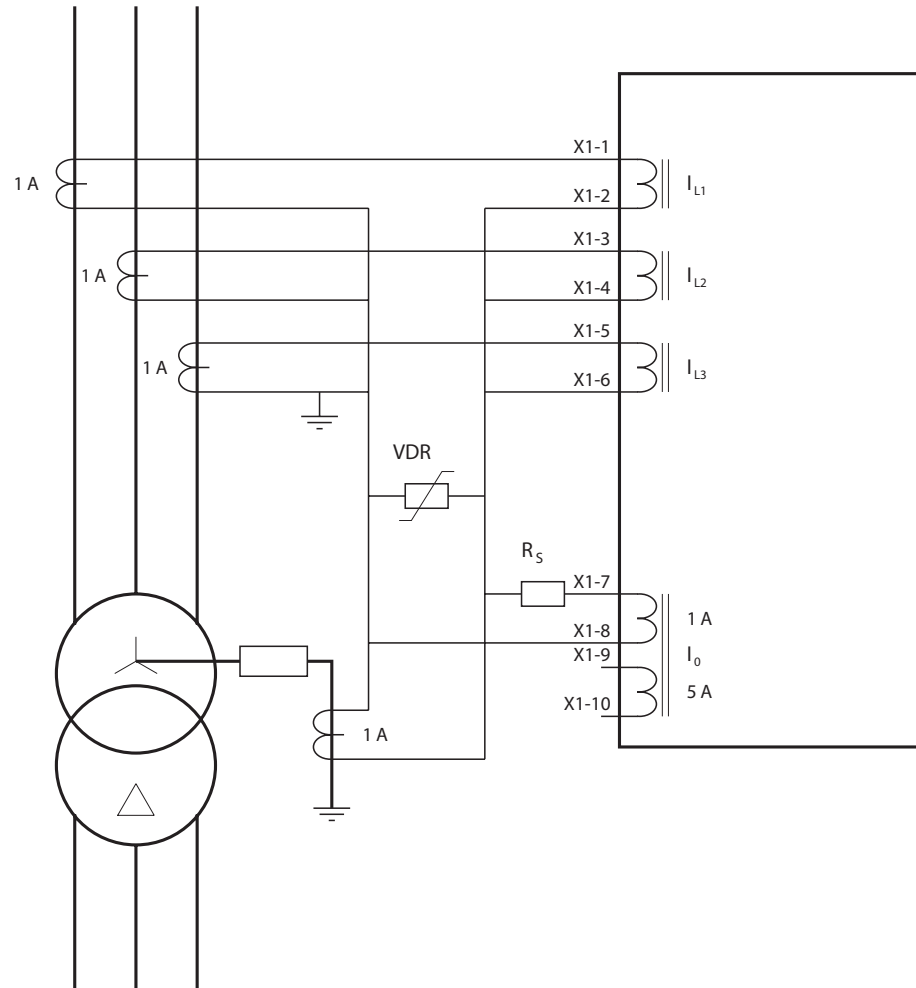

Figure 10.2: Overcurrent and restricted earth fault protection of transformer's wye winding. All the CTs have the same ratio and the nominal secondary current is 1 A. In through fault the residual secondary currents of phase CTs and the neutral CT cancel each other and in inside fault the two residual secondary currents are summed up and forced to flow through the I0 input of the relay and the voltage limiting VDR.

10.2.1 CT Requirements

Any difference between the CTs will give a misleading residual current signal to the relay. Especially during heavy through faults (i.e. the fault is outside the protected zone) the dissimilar saturation of the CTs should not yield to a REF trip. On the other hand a very high fault current causing an unselective earth fault start or trip is not a fatal error.

Class X CT

In restricted earth fault protection the high and low side CTs should give similar responses even for high over currents.

Class X CTs will fulfil this requirement. Their performance is defined in terms of a knee-point voltage (V_{KP}), the magnetizing current at the knee point voltage and the resistance of the secondary winding at +75°C.

Knee point voltage (V_{KP}) is the secondary voltage at which a 50 % increase of primary current is needed to increase the secondary voltage by 10 %.

10.3 Calculating the stabilizing resistance R_S , VDR value and actual sensitivity

10.3.1 Value of stabilizing resistor R_S

The voltage V_S (Figure 10.1) is:

Equation 10.1:

$$V_S = I_{MAXT} \frac{CT_{SEC}}{CT_{PRIM}} R_{CT} + R_W$$

I_{MAXT} = Maximum through fault current not to cause an REF trip*

CT_{SEC} = Nominal secondary current of the CT

CT_{PRI} = Nominal primary current of the CT

R_{CT} = Resistance of CT secondary.

R_W = Total resistance of wiring, connections etc.

The CT should be of class X (see Chapter 10.2.1 CT Requirements) and the knee point voltage should be twice the calculated V_S .

The stabilizing resistor R_S is calculated as:

Equation 10.2:

$$R_S = \frac{V_S}{I_{Set}}$$

I_{SET} = Setting value of the relay as secondary value.

* Selecting a low value helps to achieve more sensitivity and helps to avoid the usage of a voltage limiting VDR. An unselective earth fault pick-up/trip is not always a problem if a fast overcurrent stage will clear the fault anyway.

10.3.2 Voltage limit

During heavy inside faults the voltage in the secondary circuit may rise to several kilovolts depending on the fault currents, CT properties and the stabilizing resistor R_S . If the secondary voltage would exceed 2 kV it should be limited using a voltage dependent resistor (VDR).

The peak voltage according a linear CT model is:

Equation 10.3:

$$V_p = I_{MAXF} \frac{CT_{SEC}}{CT_{PRIM}} B_{CT} + R_W + R_S$$

I_{MAXF} = Maximum fault current when the fault is inside the protected zone

CT_{SEC} = Nominal secondary current of the CT

CT_{PRI} = Nominal primary current of the CT

R_{CT} = Resistance of CT secondary.

R_W = Total resistance of wiring, connections, relay input etc.

R_S = Stabilizing resistor according Equation 10.2.

The peak voltage of a saturating CT can be approximated using P. Mathews' formula:

Equation 10.4:

$$V_{sp} = 2\sqrt{2V_{KP}V_P - V_{KP}^2}$$

V_{KP} = Knee point voltage of the CT. The secondary voltage at which a 50 % increase of primary current is needed to increase the secondary voltage by 10%.

V_P = Peak voltage according linear model of a CT

This approximating formula does not hold for an open circuit condition and is inaccurate for very high burden resistances.

10.3.3 Actual operating sensitivity

The differential scheme will multiply the fault current by two thus increasing the sensitivity from the actual setting. The quiescent current of the possible VDR will decrease the sensitivity from the actual setting value.

10.3.4 Example

$$CT = 2000 / 1 \text{ A}$$

$$V_{KP} = 100 \text{ V}$$

$$I_{MAXT} = 16 \text{ kA} = 8 \times I_N$$

$$I_{REF} = 5 \% = 50 \text{ mA, setting value scaled to secondary level}$$

$$R_{CT} = 6 \ \Omega$$

$$R_W = 0.4 \ \Omega$$

$$I_{MAXF} = 25 \text{ kA}$$

Maximum secondary voltage during a through fault (Equation 10.1):

$$V_S = 16000 \frac{1}{2000} 6 + 0.4 = 51.2 \text{ V}$$

Conclusion: The knee point voltage of 100 V is acceptable being about twice the V_S .

Serial resistance for the relay input (Equation 10.2):

$$R_S = \frac{51.2}{0.05} = 1024 \ \Omega \approx 1000 \ \Omega$$

Maximum peak voltage during inside fault using a linear model for CT (Equation 10.3):

$$V_p = 25000 \frac{1}{2000} (6 + 0.4 + 1000) = 12.6 \text{ kV}$$

Approximation of peak voltage during inside fault using a non-linear model for a saturating CT (Equation 10.4):

$$V_{sp} = 2\sqrt{2 \cdot 100(12600 - 100)} = 3.2 \text{ kV}$$

This is a too high value and a VDR must be used to reduce the voltage below 3 kV.

A zinc oxide varistor (i.e. VDR, METROSIL) of 1 kV will limit the voltage. Using a 400 J model allows two 20 VA CTs feeding ten times their nominal power during one second before the energy capacity of the varistor is exceeded.

10.4 Current Transformer Selection

Iron core current transformers (CT) are accurate in amplitude and phase when used near their nominal values. At very low and at very high currents they are far from ideal. For over-current and differential protection, the actual performance of CTs at high currents must be checked to ensure correct function of the protection relay.

10.4.1 CT classification according IEC 60044-1, 1996

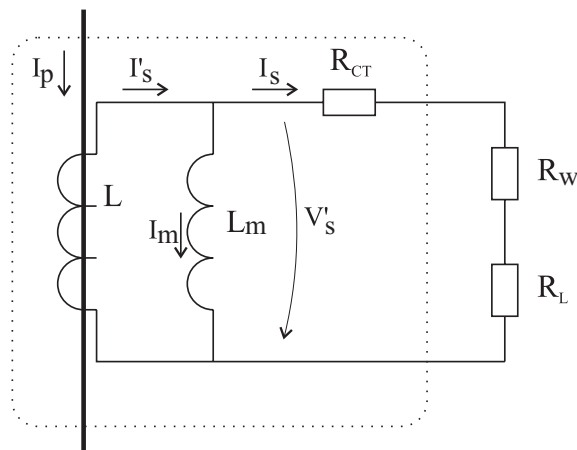

Figure 10.3: A CT equivalent circuit. L_m is the saturable magnetisation inductance, L is secondary of an ideal current transformer, R_{CT} is resistance of the CT secondary winding, R_W is resistance of wiring and R_L is the burden i.e. the protection relay.

Composite error ϵ_C

Composite error is the difference between the ideal secondary current and the actual secondary current under steady-state conditions. It includes amplitude and phase errors and also the effects of any possible harmonics in the exciting current.

Equation 10.5:

$$\epsilon_C = \frac{\sqrt{\frac{1}{T} \int_0^T (K_N i_s - i_p)^2 dt}}{I_P} \cdot 100\%$$

T = Cycle time

K_N = Rated transformation ratio $I_{NPrimary} / I_{Nsecondary}$

i_s = Instantaneous secondary current

i_p = Instantaneous primary current

I_P = Rms value of primary current

NOTE: All current based protection functions of VAMP relays, except arc protection, thermal protection and 2nd harmonic blocking functions, are using the fundamental frequency component of the measured current. The IEC formula includes an RMS value of the current. That is why the composite error defined by IEC 60044-1 is not ideal for VAMP relays. However the difference is not big enough to prevent rough estimation.

Standard accuracy classes

At rated frequency and with rated burden connected, the amplitude error, phase error and composite error of a CT shall not exceed the values given in the following table.

Accuracy class	Amplitude error at rated primary current (%)	Phase displacement at rated primary current (°)	Composite error ϵ_C at rated accuracy limit primary current (%)
5P	±1	±1	5
10P	±3	-	10

Marking:

The accuracy class of a CT is written after the rated power.

E.g. 10 VA **5P10**, 15 VA **10P10**, 30 VA **5P20**

Accuracy limit current I_{AL}

Current transformers for protection must retain a reasonable accuracy up to the largest relevant fault current. Rated accuracy limit current is the value of primary current up to which the CT will comply with the requirements for composite error ϵ_C .

Accuracy limit factor k_{ALF}

The ratio of the accuracy limit current to the rated primary current.

Equation 10.6:

$$K_{ALF} = \frac{I_{AL}}{I_N}$$

The standard accuracy limit factors are 5, 10, 15, 20 and 30.

Marking:

Accuracy limit factor is written after the accuracy class.

E.g. 0 VA **5P10**, 15 VA **10P10**, 30 VA **5P20**.

The actual accuracy limit factor k_A depends on the actual burden.

Equation 10.7:

$$k_A = k_{ALF} \frac{|S_i + S_N|}{|S_i + S_A|}$$

- k_{ALF} = Accuracy limit factor at rated current and rated burden
- S_i = Internal secondary burden. (Winding resistance RCT in Figure 10.3)
- S_N = Rated burden
- S_A = Actual burden including wiring and the load.

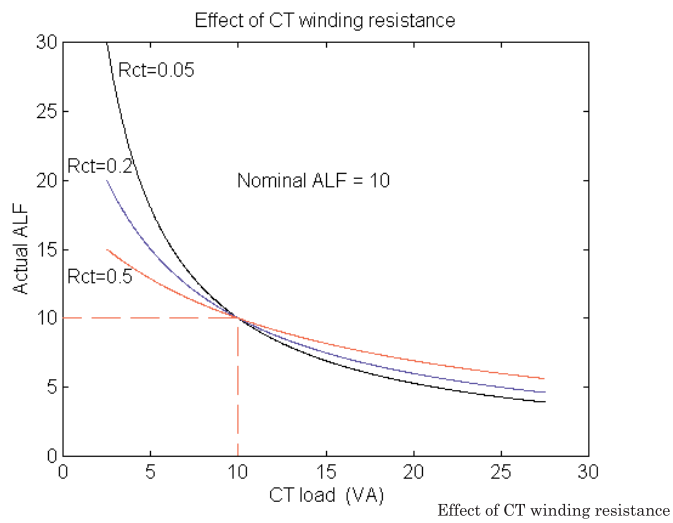

Figure 10.4: This figure of Equation 10.4.1 3 shows that it is essential to know the winding resistance R_{CT} of the CT if the load is much less than the nominal. A 10 VA 5P10 CT with 25% load gives actual ALF values from 15 - 30 when the winding resistance varies from 0.5 Ω to 0.05 Ω.

10.4.2 CT Requirement for Protection

When the through current equals and exceeds $k_A \times I_N$ there may be enough secondary differential current to trip a relay although there is no in zone fault. This is because the CTs are unique and they do not behave equally when approaching saturation.

To avoid false trips caused by heavy through faults the actual accuracy limit factor k_A of the CTs should exceed the relative setting I_{SET} of the non-stabilized differential stage.

Equation 10.8:

$$k_A > c \cdot I_{SET} \cdot \frac{I_{NTra}}{I_{NCT}}$$

c = Safety factor

I_{SET} = Relative setting of the non-stabilized differential current stage

I_{NTra} = Rated current of the transformer (primary side or secondary side)

I_{NCT} = Rated primary current of the CT (primary side or secondary side)

Using slightly smaller safety factor than indicated in the table will increase the setting inaccuracy.

Protection application	Safety factor c
Overcurrent	2
Earth-fault, cable transformer	3
Earth-fault overcurrent, sum of three phase currents *	6
Transformer differential, Δ -winding or unearthened Y-winding	3
Transformer differential, earthed Y-winding	4
Generator differential	3

* Sensitive earth-fault current settings, $< 5\% \times I_N$, should be avoided in this configuration because a set of three CTs are not exactly similar and will produce some secondary residual current even though there is no residual current in the primary side.

Formula to solve needed CT power S_N

By replacing the complex power terms with corresponding resistances in Equation 10.7, we get

Equation 10.9:

$$k_A = k_{ALF} \frac{R_{CT} + R_N}{R_{CT} + R_W + R_L}$$

where the nominal burden resistance is

Equation 10.10:

$$R_N = \frac{S_N}{I_{NCTsec}^2}$$

R_{CT} = Winding resistance (See Figure 10.3)

R_W = Wiring resistance (from CT to the relay and back)

R_L = Resistance of the protection relay input

S_N = Nominal burden of the CT

I_{NCTsec} = Nominal secondary current of the CT

By solving S_N and substituting k_A according Equation 10.9, we get

Equation 10.11:

$$S_N > \left[\frac{c I_{SET} I_{NCTra}}{k_{ALF} I_{NCT}} (R_{CT} + R_W + R_L) - R_{CT} \right] I_{NCTsec}^2$$

10.4.3

Example

Transformer:

16 MVA YNd11 $Z_k = 10\%$

110 kV / 21 kV (84 A / 440 A)

CT's on HW side:

100/5 5P10

Winding resistance $R_{CT} = 0.07 \Omega$

(R_{CT} depends on the CT type, I_{NCT} and power rating. Let's say that the selected CT type, 100 A and an initial guess of 15 VA yields to 0.07 Ω .)

Safety factor $c = 4$.

(Transformer differential, earthed Y.)

CTs on LV side:

500/5 5P10

(Max. Short circuit current is 4400 A = 8.8 x 500 A)

Winding resistance RCT = 0.28 Ω

(RCT depends on the CT type, INCT and power rating. Let's say that the selected CT type, 500 A and an initial guess of 15 VA yields to 0.28 Ω)

Safety factor c = 3.

(Transformer differential, Δ.)

Differential current setting of the non-stabilized stage ΔI>>:

$$I_{SET} = 9 \times I_N$$

$$R_L = 0.008 \Omega \text{ Typical burden of a VAMP relay current input.}$$

$$R_{WHV} = 0.138 \Omega \text{ Wiring impedance of high voltage side.} \\ (2 \times 16 \text{ m, } 4 \text{ mm}^2)$$

$$R_{WLV} = 0.086 \Omega \text{ Wiring impedance of low voltage side.} \\ (2 \times 10 \text{ m, } 4 \text{ mm}^2)$$

Equation 10.12:

$$S_N > \left[\frac{4 \cdot 9 \cdot 84}{10 \cdot 100} \cdot (0.07 + 0.138 + 0.008) - 0.07 \right] \cdot 5^2 = 14.6$$

=> 15 VA is a good choice for HV side.

And on the LV side

Equation 10.13:

$$S_N > \left[\frac{3 \cdot 9 \cdot 440}{10 \cdot 500} \cdot (0.28 + 0.086 + 0.008) - 0.28 \right] \cdot 5^2 = 15.2$$

=> 15 VA is a good choice for LV side.

10.5 Protection of a Dyn11 transformer

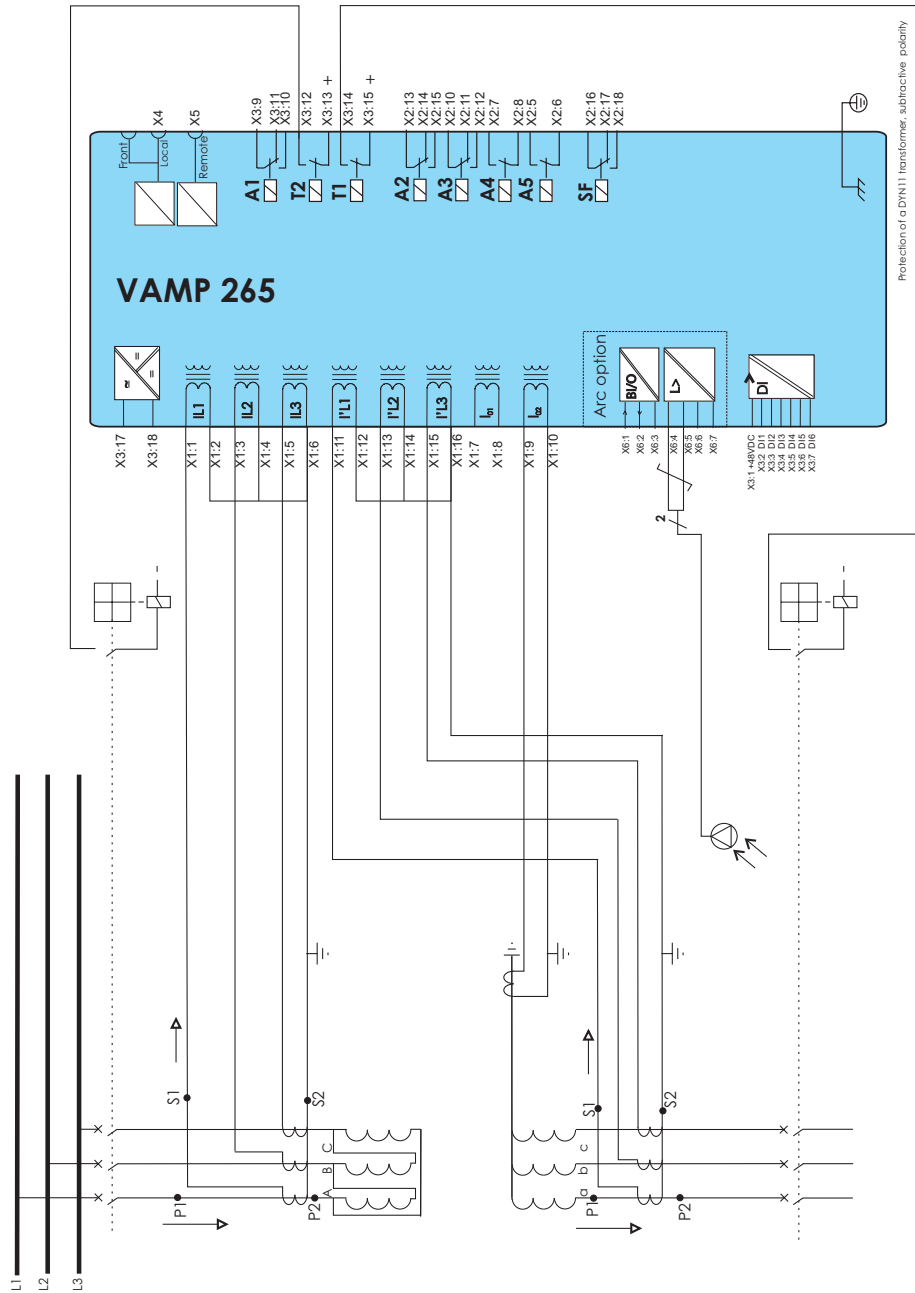

Figure 10.5: Differential protection of a Dyn11 transformer using VAMP 265. Primary and secondary current transformers are connected according to subtractive polarity.

Setting

ConnGrp	Dy11
IoCmps	OFF
I'oCmps	ON
Un	High side voltage
U'n	Low side voltage

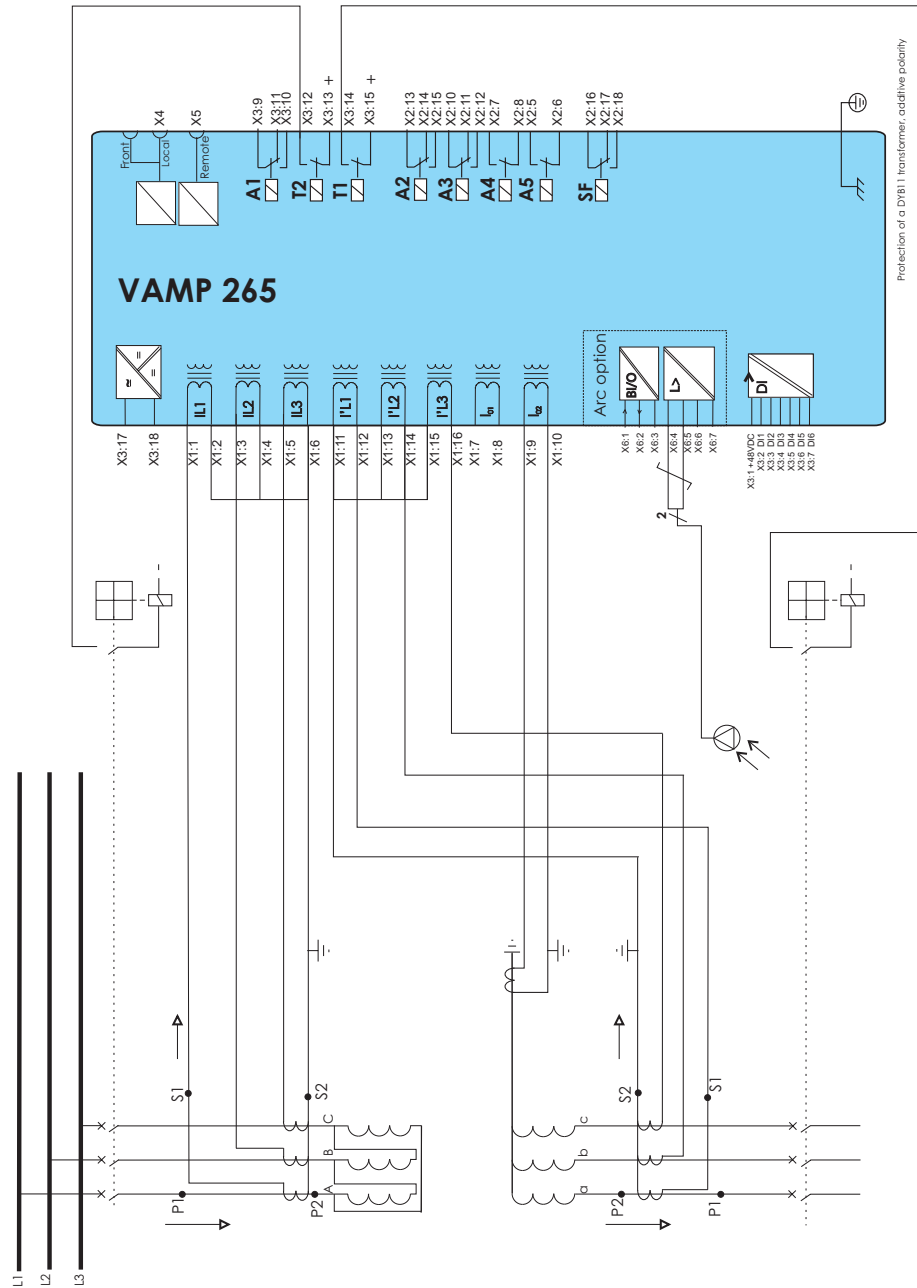

Figure 10.6: Differential protection of a Dyn11 transformer using VAMP 265. Primary and secondary current transformers are connected according to additive polarity.

Setting

ConnGrp	Dy11
IoCmps	OFF
I'oCmps	ON
Un	High side voltage
U'n	Low side voltage

10.6 Protection of a YNd11 transformer

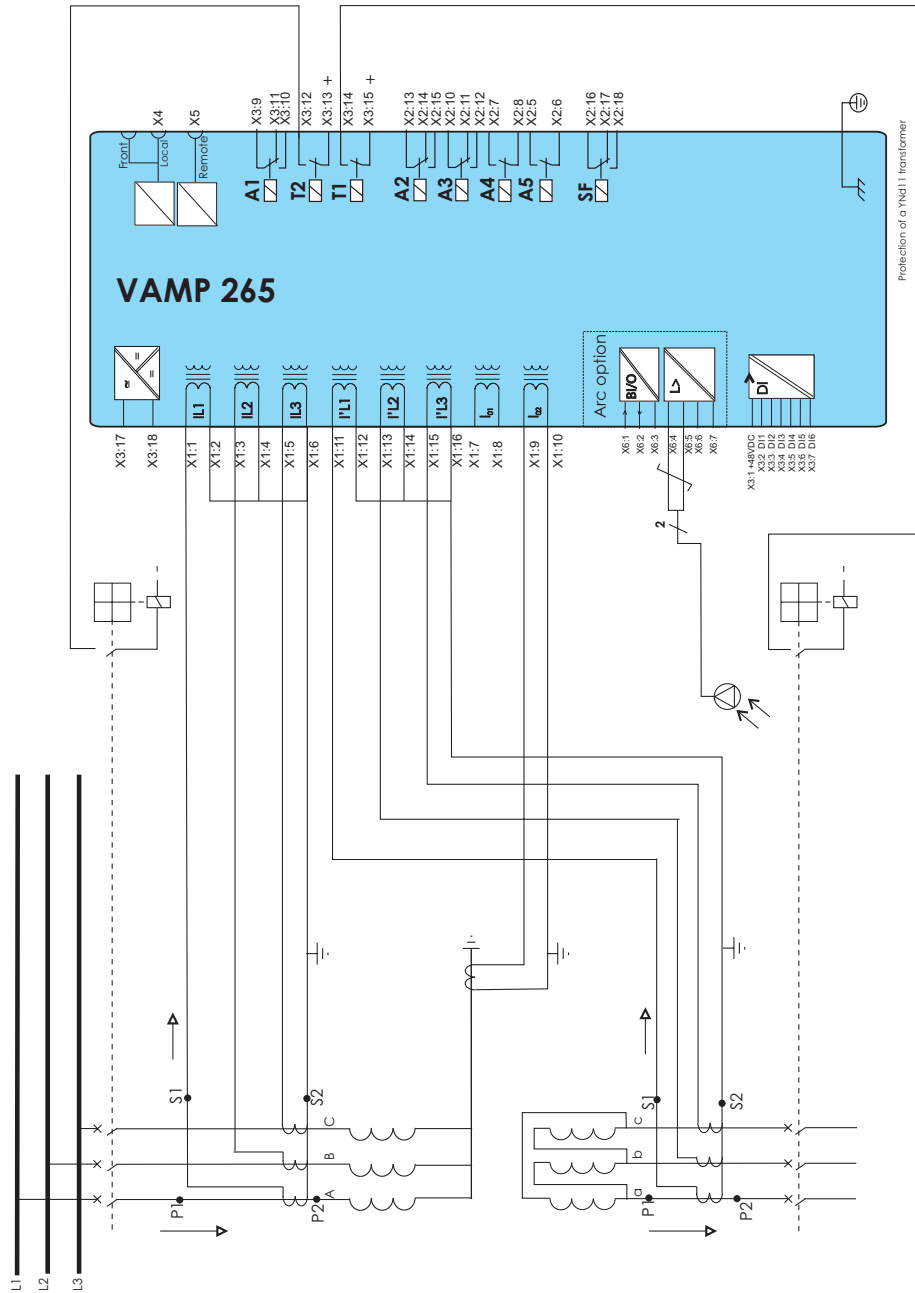

Figure 10.7: Differential protection of a YNd11 transformer using VAMP 265.

Setting

ConnGrp	Yd11
IoCmps	ON
I'oCmps	OFF
Un	High side voltage
U'n	Low side voltage

10.7 Protection of generator and block transformer

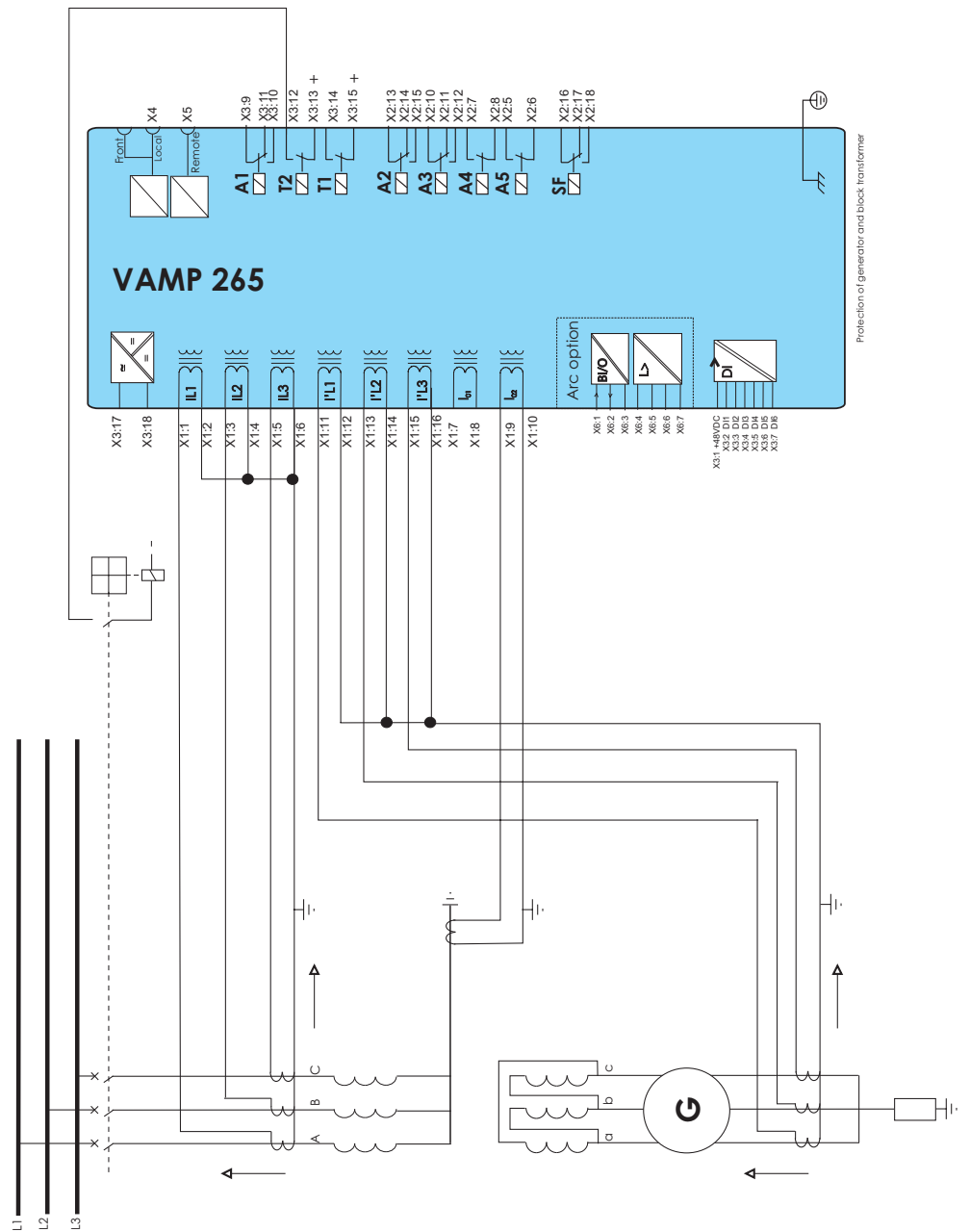

Figure 10.8: Differential protection of a YNd11 transformer and generator using VAMP 265.

Setting

ConnGrp	Yd11
IoCmps	ON
I'oCmps	OFF
Un	High side voltage
U'n	Low side voltage

10.8 Application example of differential protection using VAMP 265

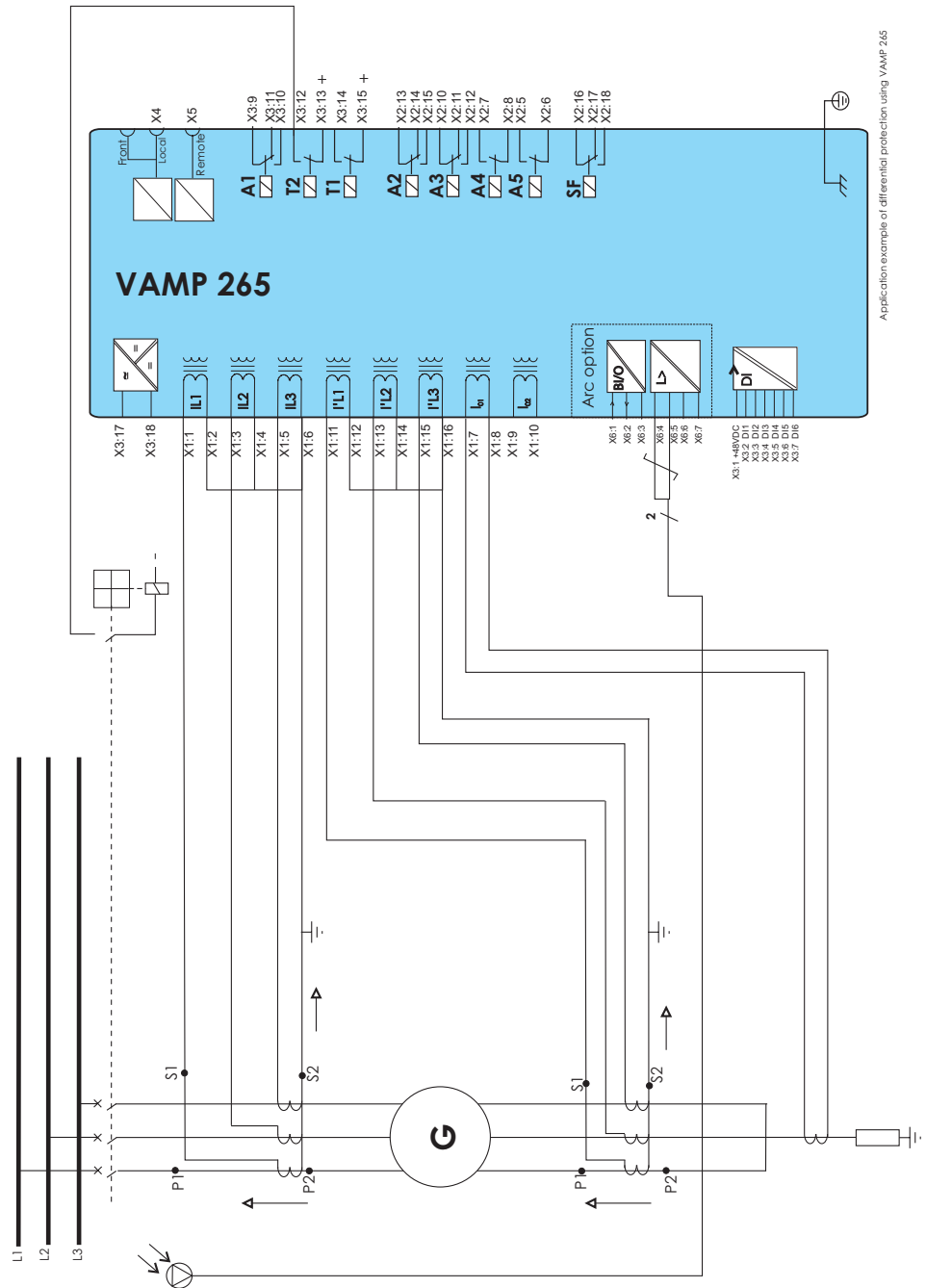

Figure 10.9: Differential protection of a generator using VAMP 265.

Settings:

ConnGrp	Yy0
IoCmps	OFF
I'oCmps	OFF
Un	Generator nominal voltage
U'n	Generator nominal voltage

10.9 Trip circuit supervision

Trip circuit supervision is used to ensure that the wiring from the protective device to a circuit-breaker is in order. This circuit is unused most of the time, but when a protection device detects a fault in the network, it is too late to notice that the circuit-breaker cannot be tripped because of a broken trip circuitry.

The digital inputs of the device can be used for trip circuit monitoring. The dry digital inputs are most suitable for trip circuit supervision. The first six digital inputs of VAMP 200 series relays are not dry and an auxiliary miniature relay is needed, if these inputs are used for trip circuit supervision.

Also the closing circuit can be supervised, using the same principle.

In many applications the optimum digital inputs for trip circuit supervision are the optional inputs DI19 and DI20. They don't share their terminals with any other digital inputs.

10.9.1 Trip circuit supervision with one digital input

The benefits of this scheme is that only one digital inputs is needed and no extra wiring from the relay to the circuit breaker (CB) is needed. Also supervising a 24 Vdc trip circuit is possible.

The drawback is that an external resistor is needed to supervise the trip circuit on both CB positions. If supervising during the closed position only is enough, the resistor is not needed.

- The digital input is connected parallel with the trip contacts (Figure 10.10).
- The digital input is configured as Normal Closed (NC).
- The digital input delay is configured longer than maximum fault time to inhibit any superfluous trip circuit fault alarm when the trip contact is closed.
- The digital input is connected to a relay in the output matrix giving out any trip circuit alarm.
- The trip relay should be configured as non-latched. Otherwise, a superfluous trip circuit fault alarm will follow after the trip contact operates, and the relay remains closed because of latching.
- By utilizing an auxiliary contact of the CB for the external resistor, also the auxiliary contact in the trip circuit can be supervised.
- When using the dry digital inputs DI7 – , using the other inputs of the same group, sharing a common terminal, is limited.
- When using the wet digital inputs DI1 – DI6, an auxiliary relay is needed.

Using optional DI19 or DI20

NOTE: In the VAMP 265, only the optional digital inputs DI19 and DI20 are dry (see the ordering code for this option).

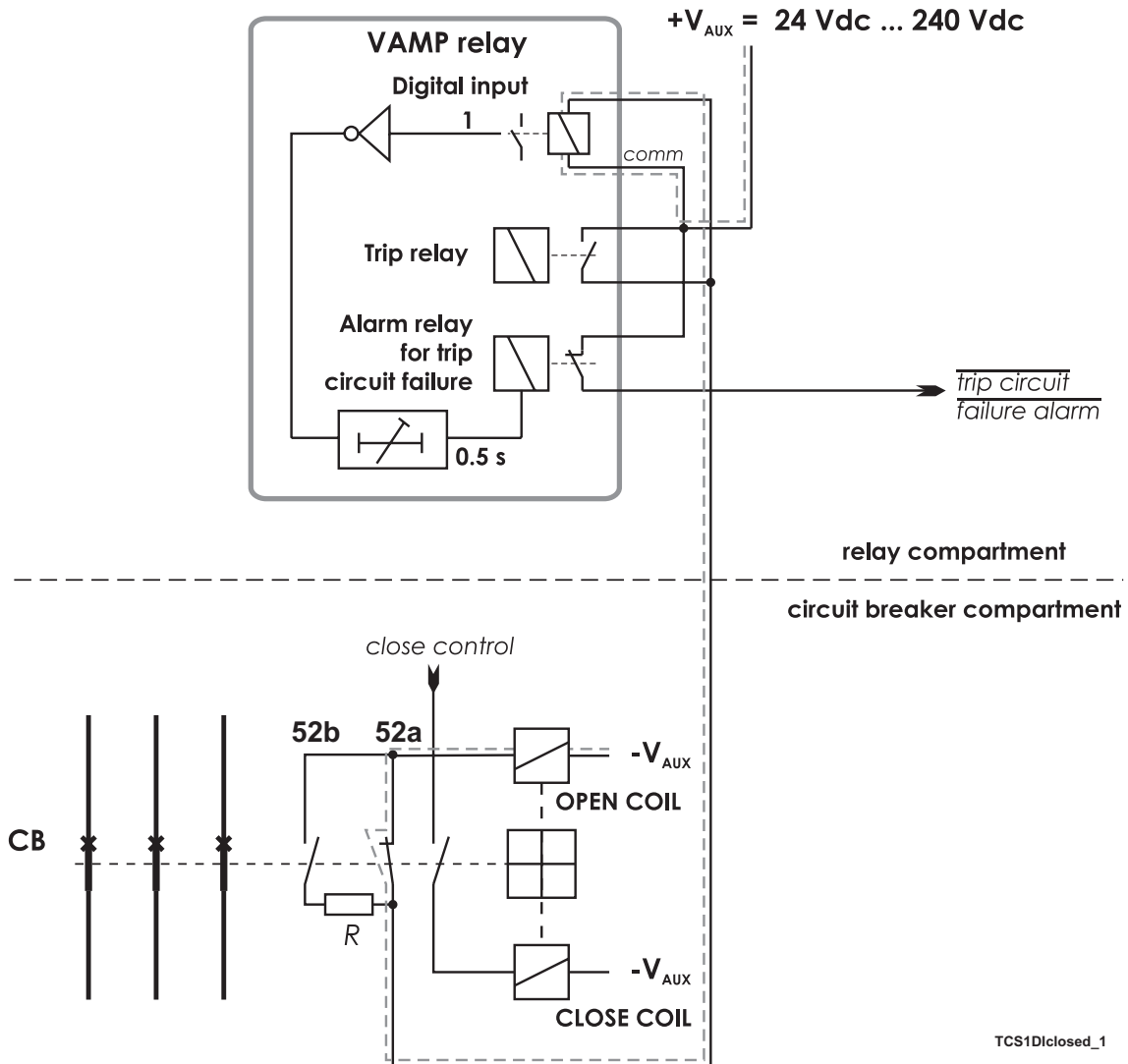

Figure 10.10: Trip circuit supervision using a single digital input and an external resistor R. The circuit-breaker is in the closed position. The supervised circuitry in this CB position is double-lined. The digital input is in active state when the trip circuit is complete. This is applicable for dry inputs DI19 – DI20.

NOTE: The need for the external resistor R depends on the application and circuit breaker manufacturer's specifications.

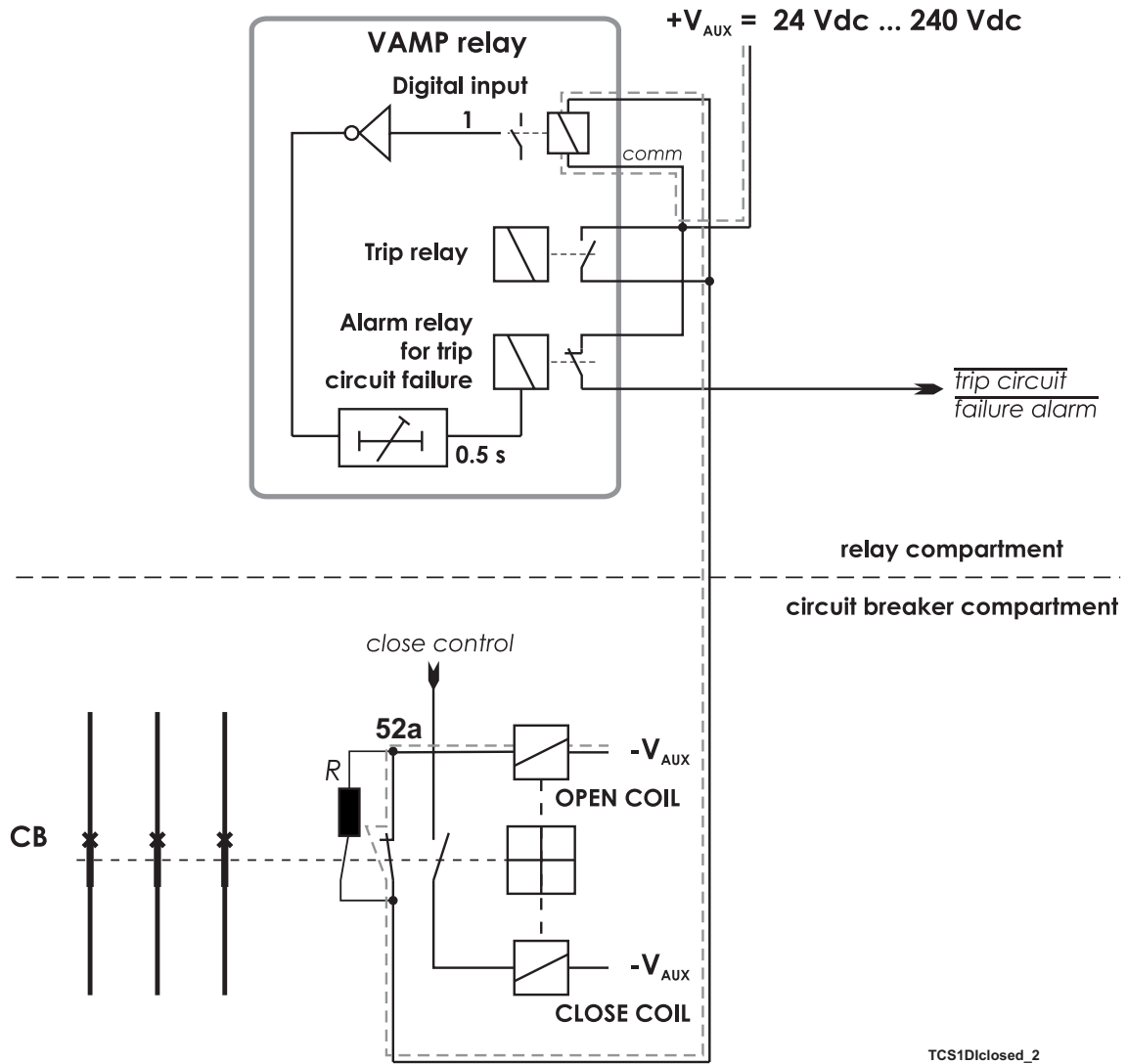
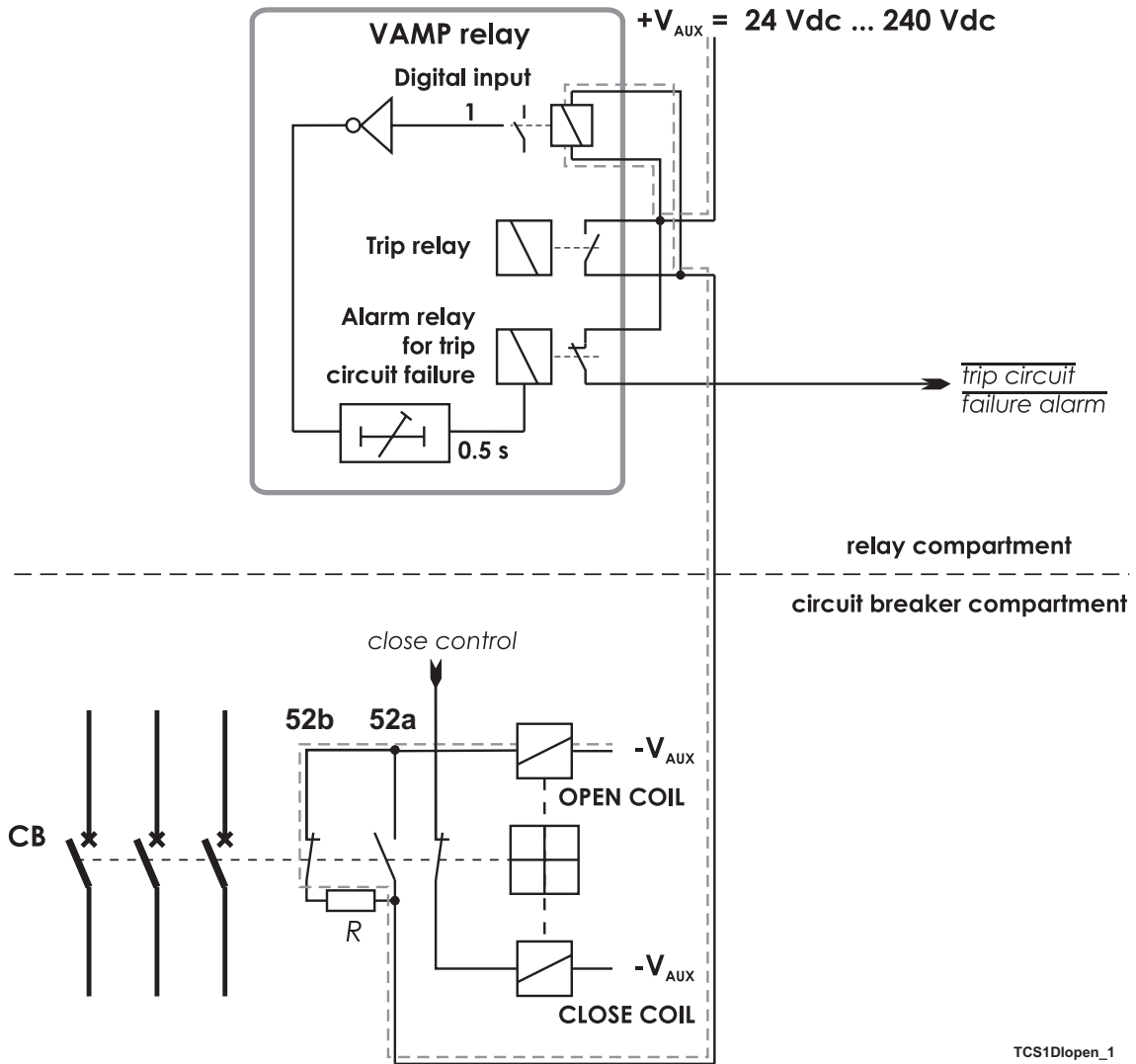
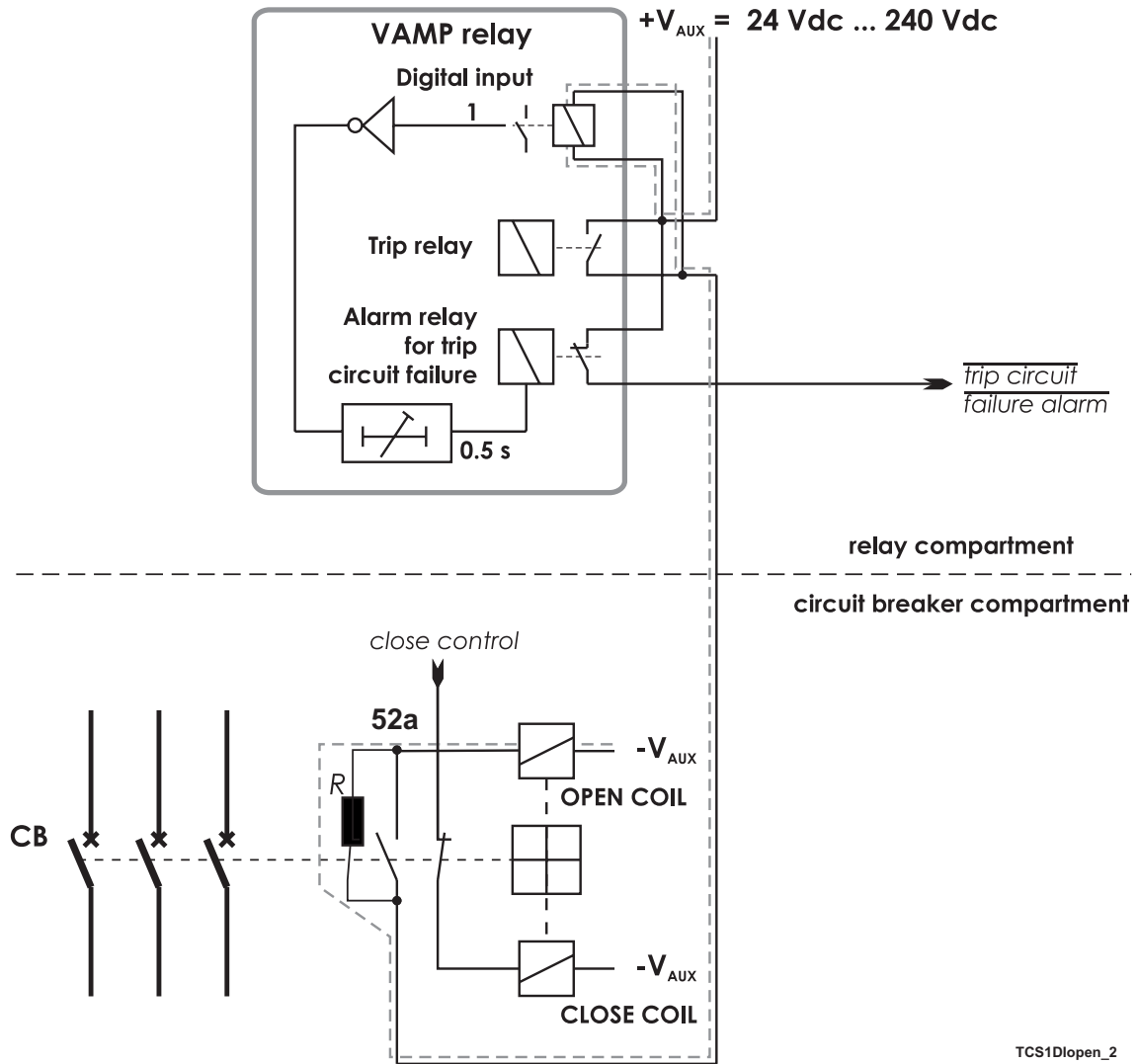

Figure 10.11: Alternative connection without using circuit breaker 52b auxiliary contacts. Trip circuit supervision using a single digital input and an external resistor R. The circuit-breaker is in the closed position. The supervised circuitry in this CB position is double-lined. The digital input is in active state when the trip circuit is complete. This is applicable for dry inputs DI19 – DI20.



TCS1Dlopen_1

Figure 10.12: Trip circuit supervision using a single dry digital input, when the circuit breaker is in open position.



TCS1Dlopen_2

Figure 10.13: Alternative connection without using circuit breaker 52b auxiliary contacts. Trip circuit supervision using a single dry digital input, when the circuit breaker is in open position.

DIGITAL INPUTS

DIGITAL INPUTS	
Mode	DC
Counters max value	16 bit

DIGITAL INPUTS

Input	State	Polarity	Delay	On Event	Off Event	Alarm display	Counters
1	1	NC	0.00 s	On	On	On	70
2	0	NO	0.00 s	On	On	On	0
3	0	NO	0.00 s	On	On	On	0
4	0	NO	0.00 s	On	On	On	0
5	0	NO	0.00 s	On	On	On	0
6	0	NO	0.00 s	On	On	On	0
19	0	NC	0.5 s	On	On	On	2
20	0	NO	0.00 s	On	On	On	0

Figure 10.14: An example of digital input DI19 configuration for trip circuit supervision with one dry digital input.

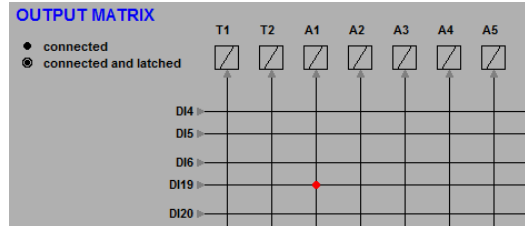

Figure 10.15: An example of output matrix configuration for trip circuit supervision with one digital input.

Example of dimensioning the external resistor R:

$U_{AUX} =$ 110 Vdc - 20 % + 10%, Auxiliary voltage with tolerance

$U_{DI} =$ 18 Vdc, Threshold voltage of the digital input

$I_{DI} =$ 3 mA, Typical current needed to activate the digital input including a 1 mA safety margin.

$P_{COIL} =$ 50 W, Rated power of the open coil of the circuit breaker. If this value is not known, 0 Ω can be used for the R_{COIL} .

$U_{MIN} =$ $U_{AUX} - 20 \% = 88 \text{ V}$

$U_{MAX} =$ $U_{AUX} + 10 \% = 121 \text{ V}$

$R_{COIL} =$ $U_{AUX}^2 / P_{COIL} = 242 \Omega$.

The external resistance value is calculated using Equation 10.14.

Equation 10.14:

$$R = \frac{U_{MIN} - U_{DI} - I_{DI} \cdot R_{Coil}}{I_{DI}}$$

$$R = (88 - 18 - 0.003 \times 242) / 0.003 = 23.1 \text{ k}\Omega$$

(In practice the coil resistance has no effect.)

By selecting the next smaller standard size we get **22 k Ω** .

The power rating for the external resistor is estimated using Equation 10.15 and Equation 10.16. The Equation 10.15 is for the CB open situation including a 100 % safety margin to limit the maximum temperature of the resistor.

Equation 10.15:

$$P = 2 \cdot I_{DI}^2 \cdot R$$

$$P = 2 \times 0.003^2 \times 22000 = 0.40 \text{ W}$$

Select the next bigger standard size, for example **0.5 W**.

When the trip contacts are still closed and the CB is already open, the resistor has to withstand much higher power (Equation 10.16) for this short time.

Equation 10.16:

$$P = \frac{U_{MAX}^2}{R}$$

$$P = 121^2 / 22000 = 0.67 \text{ W}$$

A 0.5 W resistor will be enough for this short time peak power, too. However, if the trip relay is closed for longer time than a few seconds, a 1 W resistor should be used.

Using any of the non-dry digital inputs DI1 – DI6

In this scheme an auxiliary relay is needed to connect the wet digital input to the trip circuit (Figure 10.16). The rated coil voltage of the auxiliary relay is selected according the rated auxiliary voltage used in the trip circuit. The operating voltage range of the relay should be as wide as possible to cover the tolerance of the auxiliary voltage.

In this application using the other wet inputs for other purposes is not limited unlike, when using the dry inputs.

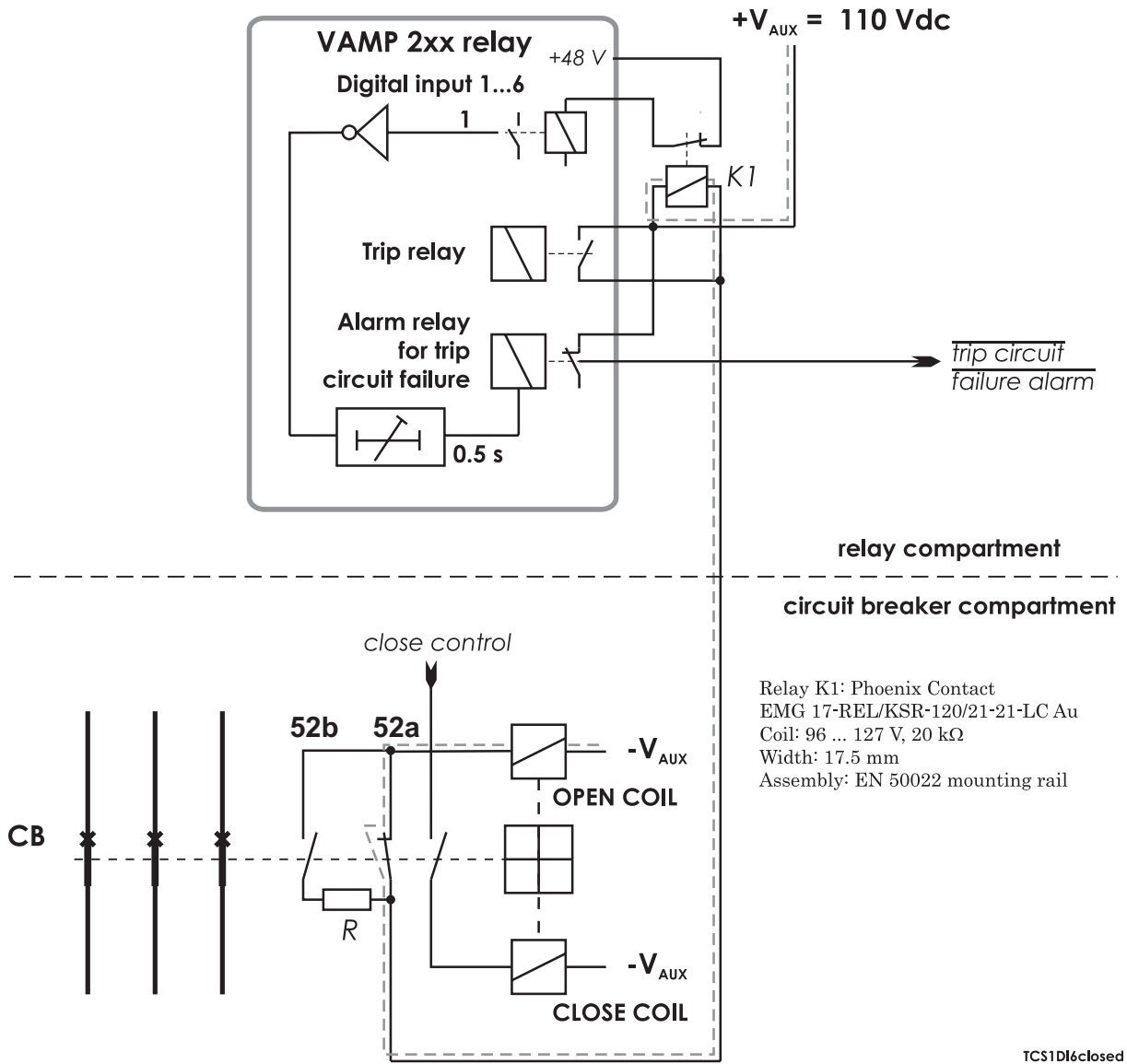

Figure 10.16: Trip circuit supervision using one of the VAMP 200 series internally wetted digital input (DI1 – DI6) and auxiliary relay K1 and an external resistor R. The circuit-breaker is in the closed position. The supervised circuitry in this CB position is double-lined. The digital input is in active state when the trip circuit is complete.

DIGITAL INPUTS							
Input	State	Polarity	Delay	On Event	Off Event	Alarm display	Counters
1	0	NC	0.5 s	Off	Off	On	0

Figure 10.17: An example of digital input DI1 configuration for trip circuit supervision with one wet digital input.

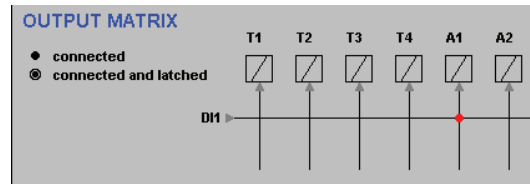

Figure 10.18: An example of output matrix configuration for trip circuit supervision with one wet digital input.

Example of dimensioning the external resistor R:

$$U_{AUX} = 110 \text{ Vdc} - 5 \% + 10\%$$

Auxiliary voltage with tolerance. Short time voltage dips more than 5 % are not critical from the trip circuit supervision point of view.

Relay type for the K1 auxiliary relay:

Phoenix Contact 2941455

EMG 17-REL/KSR-120/21-21-LC Au

$$U_{K1} = 120 \text{ Vac/dc} - 20 \% + 10\%$$

Coil voltage of the auxiliary relay K1

$$I_{K1} = 6 \text{ mA}$$

Nominal coil current of the auxiliary relay K1

$$P_{CBcoil} = 50 \text{ W}$$

Rated power of the open coil of the circuit breaker.

$$U_{MIN} = U_{AUX} - 5 \% = 104.5 \text{ V}$$

$$U_{MAX} = U_{AUX} + 10 \% = 121 \text{ V}$$

$$U_{K1MIN} = U_{K1} - 20 \% = 96 \text{ V}$$

$$U_{K1MAX} = U_{K1} + 10 \% = 132 \text{ V}$$

$$R_{K1Coil} = U_{K1} / I_{K1} = 20 \text{ k}\Omega.$$

$$I_{K1MIN} = U_{K1MIN} / R_{K1Coil} = 4.8 \text{ mA}$$

$$I_{K1MAX} = U_{K1MAX} / R_{K1Coil} = 6.6 \text{ mA}$$

$$R_{CBCoil} = U_{AUX}^2 / P_{CBcoil} = 242 \Omega.$$

The external resistance value is calculated using Equation 10.17.

Equation 10.17:

$$R = \frac{U_{MIN} - U_{K1Min}}{I_{K1Min}} - R_{CBcoil}$$

$$R = (104.5 - 96) / 0.0048 - 242 = 1529 \Omega$$

By selecting the next smaller standard size we get **1.5 kΩ**.

The power rating for the external resistor is calculated using Equation 10.18. This equation includes a 100 % safety margin to limit the maximum temperature of the resistor, because modern resistors are extremely hot at their rated maximum power.

Equation 10.18:

$$P = 2 \cdot I_{K1,Max}^2 \cdot R$$

$$P = 2 \cdot 0.0066^2 \cdot 1500 = 0.13 \text{ W}$$

Select the next bigger standard size, for example 0.5 W.

When the trip contacts are still closed and the CB is already open, the resistor has to withstand much higher power (Equation 10.16) for this short time.

$$P = 121^2 / 1500 = 9.8 \text{ W}$$

A **1 W** resistor should be selected to withstand this short time peak power. However, if the trip relay can be closed for longer time than a few seconds, a 20 W resistor should be used.

10.9.2 Trip circuit supervision with DI19 and DI20

The benefits of this scheme is that no external resistor is needed.

The drawbacks are, that two digital inputs from two separate groups are needed and two extra wires from the relay to the CB compartment is needed. Additionally the minimum allowed auxiliary voltage is 48 Vdc, which is more than twice the threshold voltage of the dry digital input, because when the CB is in open position, the two digital inputs are in series.

- The first digital input is connected parallel with the auxiliary contact of the open coil of the circuit breaker.
- Another auxiliary contact is connected in series with the circuitry of the first digital input. This makes it possible to supervise also the auxiliary contact in the trip circuit.
- The second digital input is connected in parallel with the trip contacts.
- Both inputs are configured as normal closed (NC).
- The user's programmable logic is used to combine the digital input signals with an AND port. The delay is configured longer than maximum fault time to inhibit any superfluous trip circuit fault alarm when the trip contact is closed.
- The output from the logic is connected to a relay in the output matrix giving out any trip circuit alarm.
- Both digital inputs must have their own common potential.

Using the other digital inputs in the same group as the upper DI in the Figure 10.19 is not possible in most applications. Using the other digital inputs in the same group as the lower DI in the Figure 10.19 is limited, because the whole group will be tied to the auxiliary voltage V_{AUX} .

NOTE: In many applications the optimum digital inputs for trip circuit supervision are the optional inputs DI19 and DI20 because they don't share their terminals with any other digital inputs.

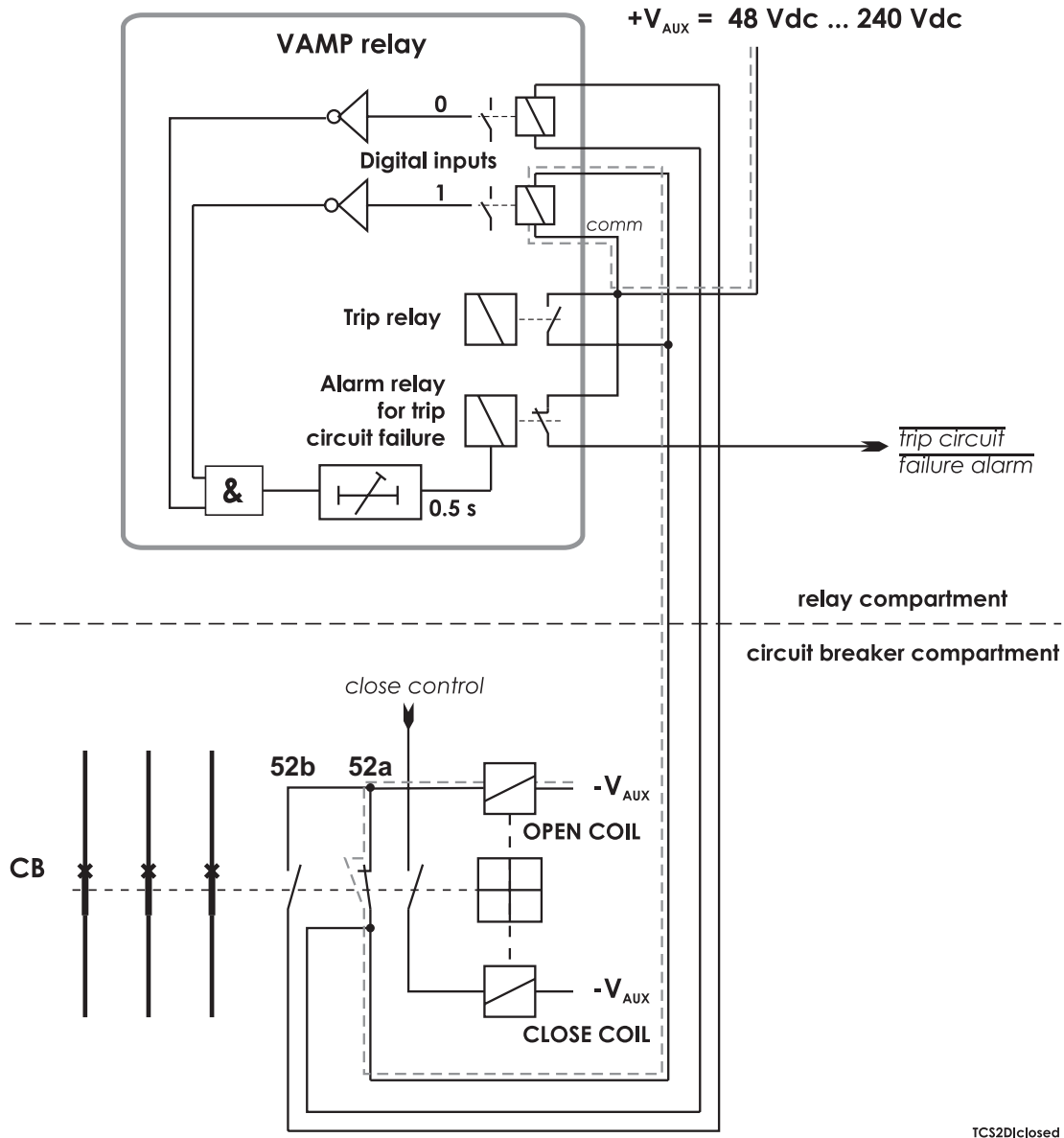

Figure 10.19: Trip circuit supervision with two digital inputs. The CB is closed. The supervised circuitry in this CB position is double-lined. The digital input is in active state when the trip circuit is complete. This is applicable for dry inputs DI7 – D20 only.

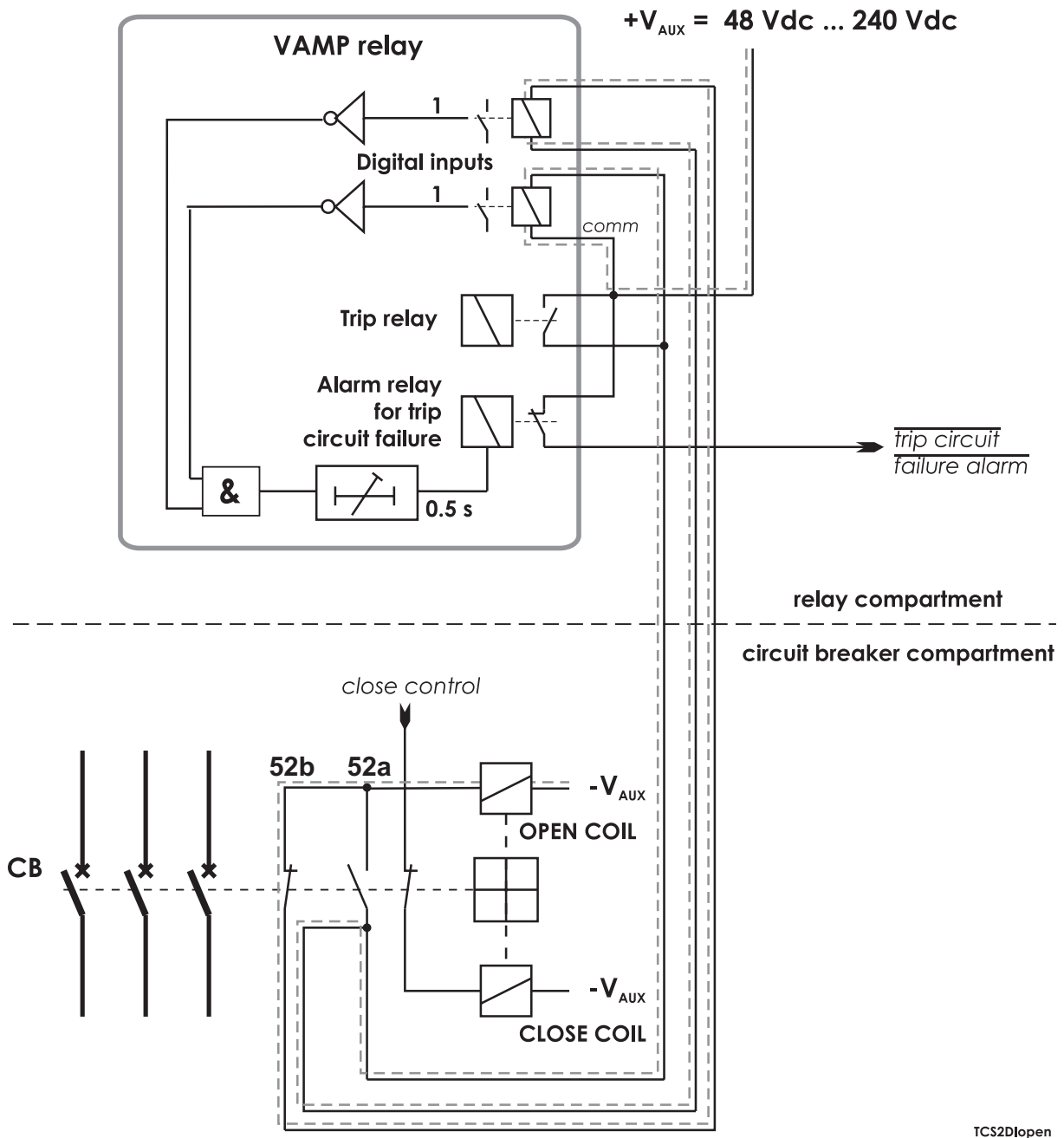

Figure 10.20: Trip circuit supervision with two digital inputs. The CB is in the open position. The two digital inputs are now in series.

DIGITAL INPUTS

DIGITAL INPUTS	
Mode	DC
Counters max value	16 bit

Input	State	Polarity	Delay	On Event	Off Event	Alarm display	Counters
1	0	NO	0.00 s	Off	Off	Off	70
2	0	NO	0.00 s	Off	Off	Off	0
3	0	NO	0.00 s	On	On	On	0
4	0	NO	0.00 s	On	On	On	0
5	0	NO	0.00 s	On	On	On	0
6	0	NO	0.00 s	On	On	On	0
19	0	NC	0.00 s	On	On	On	4
20	0	NC	0.00 s	On	On	On	0

Figure 10.21: An example of digital input configuration for trip circuit supervision with two dry digital inputs DI19 and DI20

NOTE: Only inputs DI19 and DI20 can be used for this function in VAMP 265.

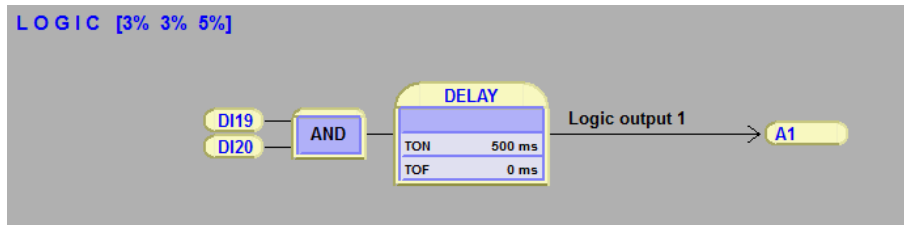

Figure 10.22: An example of logic configuration for trip circuit supervision with two dry digital inputs DI19 and DI20.

NOTE: Only inputs DI19 and DI20 can be used for this function in VAMP 265.

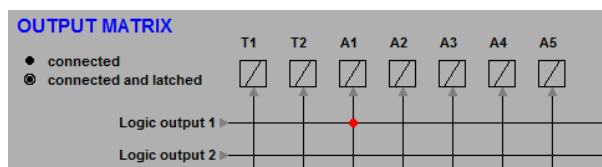
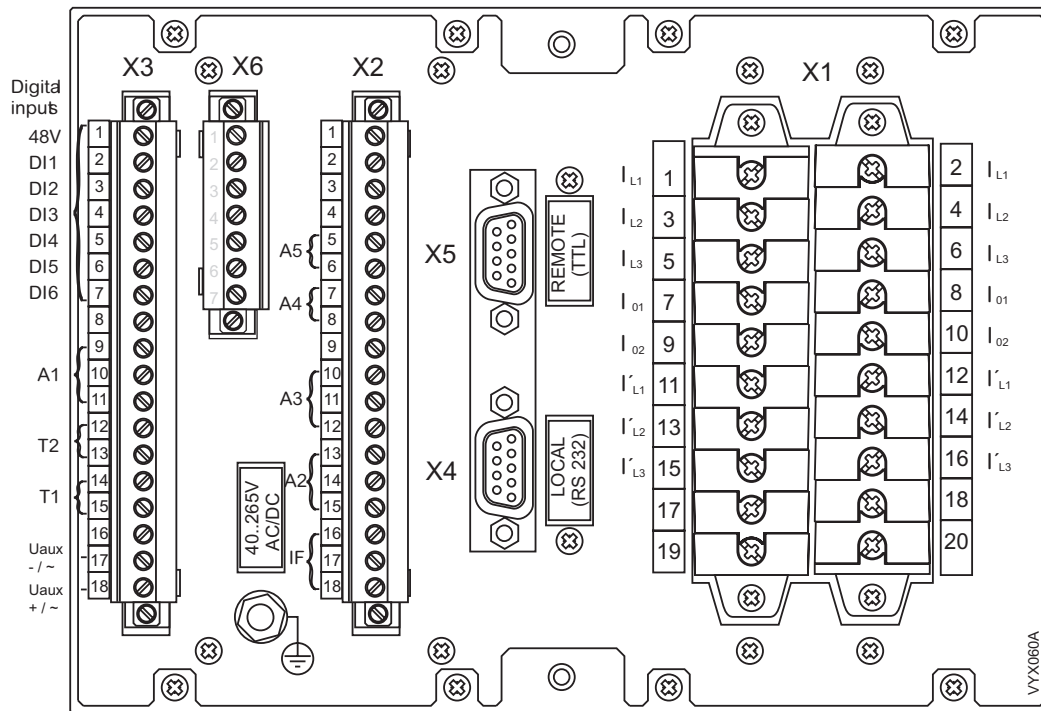

Figure 10.23: An example of output matrix configuration for trip circuit supervision with two digital inputs.

11 Connections

11.1 Rear panel



VAMP265rearPanel

Figure 11.1: Connections on the rear panel of the VAMP 265

VAMP 265 is connected to the protected object through the following measuring and control connections:

- Phase currents I_{L1} , I_{L2} and I_{L3} (terminals X1: 1-6)
- Phase currents I'_{L1} , I'_{L2} and I'_{L3} (terminals X1: 11-16)
- Earth fault current I_{01} (terminals X1: 7-8)
- Earth fault current I_{02} (terminals X1: 9-10)

Terminal X1 left side

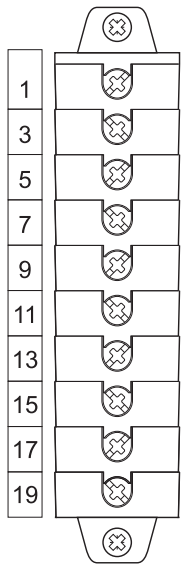





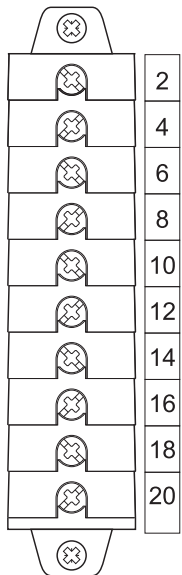













No	Symbol	Description
1	IL1	Phase current IL1 (S1), high voltage side
3	IL2	Phase current IL2 (S1), high voltage side
5	IL3	Phase current IL3 (S1), high voltage side
7	Io1	Residual current Io1 (S1)
9	Io2	Residual current Io2 (S1)
11	I'L1	Phase current I'L1 (S1), low voltage side
13	I'L2	Phase current I'L2 (S1), low voltage side
15	I'L3	Phase current I'L3 (S1), low voltage side
17	--	--
19	--	--

Terminal X1 right side



No	Symbol	Description
2	IL1	Phase current L1 (S2), high voltage side
4	IL2	Phase current L2 (S2), high voltage side
6	IL3	Phase current L3 (S2), high voltage side
8	Io1	Residual current Io1 (S2)
10	Io2	Residual current Io2 (S2)
12	I'L1	Phase current I'L1 (S2), low voltage side
14	I'L2	Phase current I'L2 (S2), low voltage side
16	I'L3	Phase current I'L3 (S2), low voltage side
18	--	--
20	--	--

Terminal X2 without the analogue output

	No	Symbol	Description
	1	--	--
	2	--	--
	3	--	--
	4	--	--
	5	A5	Alarm relay 5
	6	A5	Alarm relay 5
	7	A4	Alarm relay 4
	8	A4	Alarm relay 4
	9	--	--
	10	A3 COM	Alarm relay 3, common terminal
	11	A3 NC	Alarm relay 3, normal closed terminal
	12	A3 NO	Alarm relay 3, normal open terminal
	13	A2 COM	Alarm relay 2, common terminal
	14	A2 NC	Alarm relay 2, normal closed terminal
	15	A2 NO	Alarm relay 2, normal open terminal
	16	SF COM	Internal fault relay, common terminal
	17	SF NC	Internal fault relay, normal closed terminal
	18	SF NO	Internal fault relay, normal open terminal

Terminal X3

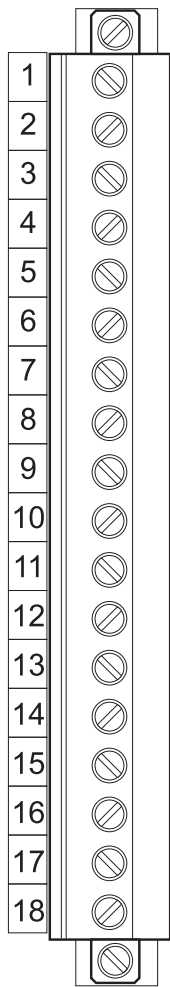

No	Symbol	Description
1	+48V	Internal control voltage for digital inputs 1 – 6
2	DI1	Digital input 1
3	DI2	Digital input 2
4	DI3	Digital input 3
5	DI4	Digital input 4
6	DI5	Digital input 5
7	DI6	Digital input 6
8	--	--
9	A1 COM	Alarm relay 1, common terminal
10	A1 NO	Alarm relay 1, normal open terminal
11	A1 NC	Alarm relay 1, normal closed terminal
12	T2	Trip relay 2
13	T2	Trip relay 2
14	T1	Trip relay 1
15	T1	Trip relay 1
16	--	--
17	Uaux -/~	Auxiliary voltage
18	Uaux +/~	Auxiliary voltage

Terminal X6

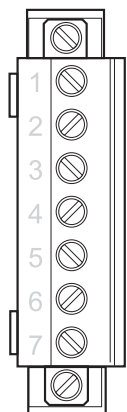

No	Symbol	Description
1	BI	External arc light input
2	BO	Arc light output
3	COM	Common for BI and BO
4	S1>+	Arc sensor 1, positive terminal *
5	S1>-	Arc sensor 1, negative terminal *
6	S2>+	Arc sensor 2, positive terminal *
7	S2>-	Arc sensor 2, negative terminal *

*) Arc sensor itself is polarity free

Terminal X6 with DI19/DI20 option

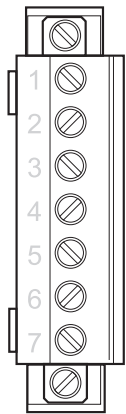

No	Symbol	Description
1	DI19	Digital input 19
2	DI19	Digital input 19
3	DI20	Digital input 20
4	DI20	Digital input 20
5	--	--
6	S1>+	Arc sensor 1, positive terminal *
7	S1>-	Arc sensor 1, negative terminal *

*) Arc sensor itself is polarity free

11.2 Auxiliary voltage

The external auxiliary voltage U_{AUX} (standard 40 – 265 V ac/dc or optional 18 – 36 Vdc) for the pin is connected to the pins X3: 17 – 18.

NOTE: When optional 18 – 36 Vdc power module is used the polarity is as follows: X3:17 negative (+), X3:18 positive (-).

11.3 Serial communication connection

The pin assignments of communication connectors including internal communication converters are presented in the following figures and tables.

11.3.1 Front panel connector

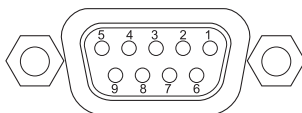

Figure 11.2: Pin numbering of the front panel D9S connector

Pin	RS232 signal
1	Not connected
2	Rx in
3	Tx out
4	DTR out (+8 V)
5	GND
6	DSR in (activates this port and disables the X4 RS232 port)
7	RTS in (Internally connected to pin 8)
8	CTS out (Internally connected to pin 7)
9	Not connected

NOTE: DSR must be connected to DTR to activate the front panel connector and disable the rear panel X4 RS232 port. (The other port in the same X4 connector will not be disabled.)

11.3.2 Rear panel connector X5 (REMOTE)

The X5 remote port communication connector options are shown in Figure 11.3. The connector types are listed in Table 11.1.

Without any internal options, X5 is a TTL port for external converters. Some external converters (VSE) are attached directly to the rear panel and X5. Some other types (VEA, VPA) need various TTL/RS-232 converter cables. The available accessories are listed in Chapter 14 Order information.

2 & 4-wire galvanically isolated RS-485 (Figure 11.4), internal options for fibre optic (Figure 11.5), and Profibus (Figure 11.6) are available. See ordering code in Chapter 14 Order information.

Table 11.1: Physical interface and connector types of remote port X5 with various options. Serial interface (A) is the default.

Order Code	Communication interface	Connector type	Pin usage
A	Serial interface for external converters only (REMOTE port)	D9S	1 = reserved 2 = TX_out / TTL 3 = RX_in /TTL 4 = RTS out /TTL 7 = GND 9 = +8V out
B	Plastic fibre interface (REMOTE port)	HFBR-0500	
C	Profibus interface (REMOTE port)	D9S	3=RXD/TXD+/P 4=RTS 5= GND 6=+5V 8= RXD/TXD-/N
D	RS-485, isolated (REMOTE port)	screw terminal	1= Signal ground 2= Reciever - 3= Reciever + 4= Transmitter - 5= Transmitter +
E	Glass fibre interface (62.5/125 µm) (REMOTE port)	ST	
F	Plastic / glass (62.5/125 µm) fibre interface (REMOTE port)	HFBR-0500/ST	Plastic Rx Glass Tx

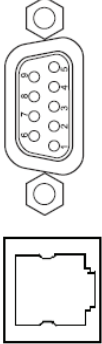
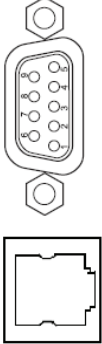
Order Code	Communication interface	Connector type	Pin usage
G	Glass (62.5/125 μm) / plastic fibre interface (REMOTE port)	ST/HFBR-0500	Glass Rx Plastic Tx
H	Ethernet interface and Serial interface for external converters only (REMOTE port)	D9S and RJ-45 	D-connector: 1 = reserved 2 = TX_out / TTL 3 = RX_in /TTL 4 = RTS out /TTL 7 = GND 9 = +8V out RJ-45 connector: 1=Transmit+ 2=Transmit- 3=Receive+ 4=Reserved 5=Reserved 6=Receive- 7=Reserved 8=Reserved
M	10Mbps Ethernet interface with IEC 61850 and Serial interface for external converters only (REMOTE port)	D9S and RJ-45 	D-connector: 1 = reserved 2 = TX_out / TTL 3 = RX_in /TTL 4 = RTS out /TTL 7 = GND 9 = +8V out RJ-45 connector: 1=Transmit+ 2=Transmit- 3=Receive+ 4=Reserved 5=Reserved 6=Receive- 7=Reserved 8=Reserved

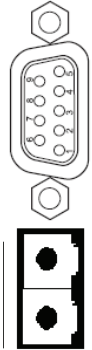
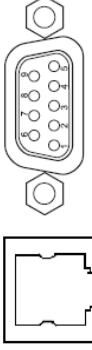
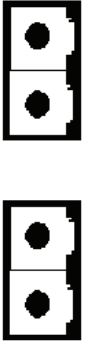
Order Code	Communication interface	Connector type	Pin usage
O	100 Mbps Ethernet fibre interface with IEC 61850 and Serial interface for external converters only (REMOTE port)	D9S and LC 	D-connector: 1 = reserved 2 = TX_out / TTL 3 = RX_in /TTL 4 = RTS out /TTL 7 = GND 9 = +8V out Fiber connector: TX=Upper LC-connector RX=Lower LC-connector
P	100Mbps Ethernet interface with IEC 61850 and Serial interface for external converters only (REMOTE port)	D9S and RJ-45 	D-connector: 1 = reserved 2 = TX_out / TTL 3 = RX_in /TTL 4 = RTS out /TTL 7 = GND 9 = +8V out RJ-45 connector: 1=Transmit+ 2=Transmit- 3=Receive+ 4=Reserved 5=Reserved 6=Receive- 7=Reserved 8=Reserved
R	100 Mbps Ethernet fibre interface with IEC 61850	2 x LC 	LC-connector from top: -Port 2 Tx -Port 2 Rx -Port 1 Tx -Port 1 Rx

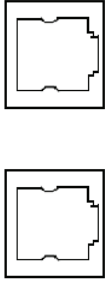
Order Code	Communication interface	Connector type	Pin usage
S	100Mbps Ethernet interface with IEC 61850	2 x RJ-45 	1=Transmit+ 2=Transmit- 3=Receive+ 4=Reserved 5=Reserved 6=Receive- 7=Reserved 8=Reserved

NOTE: In VAMP device, RS485 interfaces a positive voltage from Tx+ to Tx- or Rx+ to Rx- does correspond to the bit value “1”. In X5 connector the optional RS485 is galvanically isolated.

In 2-wire mode the receiver and transmitter are internally connected in parallel. See the table below.

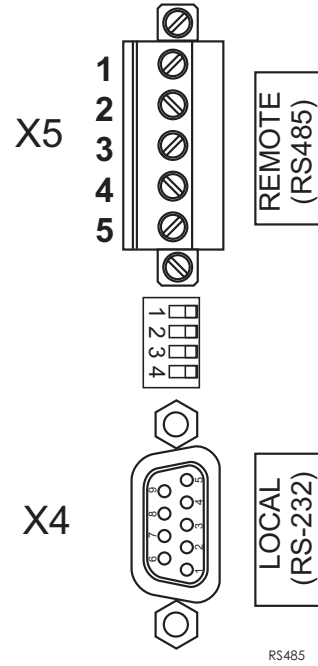
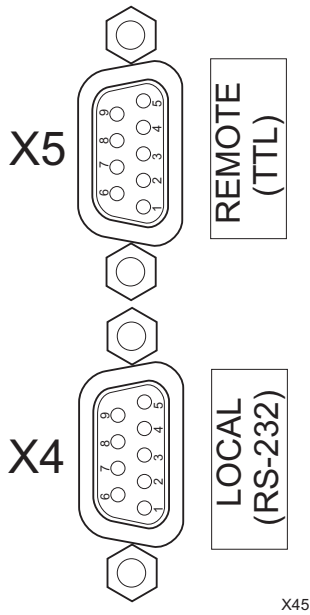

Figure 11.3: Pin numbering of the rear communication ports, REMOTE TTL

Figure 11.4: Pin numbering of the rear communication ports, REMOTE RS-485

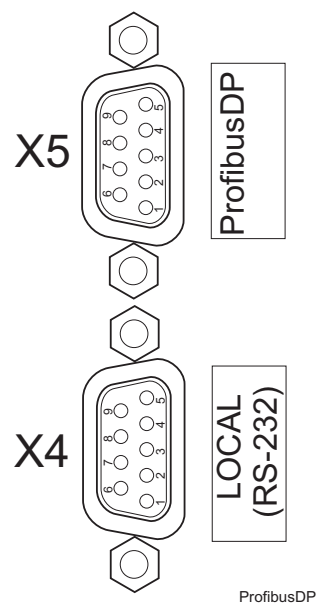
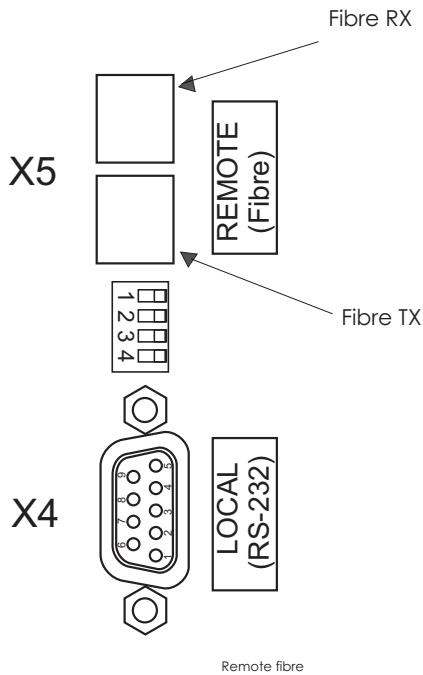

Figure 11.5: Picture of rear communication port, REMOTE FIBRE

Figure 11.6: Pin numbering of the rear communication ports, Profibus DP

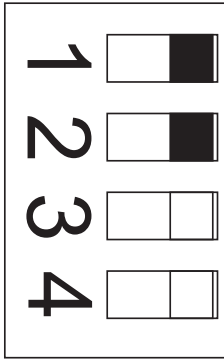

Figure 11.7: Dip switches in RS-485 and optic fibre options.

Dip switch number	Switch position	Function	Function
		RS-485	Fibre optics
1	Left	2 wire connection	Echo off
1	Right	4 wire connection	Echo on
2	Left	2 wire connection	Light on in idle state
2	Right	4 wire connection	Light off in idle state
3	Left	Termination On	Not applicable
3	Right	Termination Off	Not applicable
4	Left	Termination On	Not applicable
4	Right	Termination Off	Not applicable

11.3.3 X4 rear panel connector (local RS232 and extension RS485 ports)

Rear panel port (LOCAL)	Pin	Signal
X4	1	Not connected
	2	Rx in, RS232 local
	3	Tx out, RS232 local
	4	DTR out (+8 V)
	5	GND
	6	Not connected
	7	B- RS485 extension port
	8	A+ RS485 extension port
	9	IRIG-B input

NOTE: In VAMP devices, a positive RS485 voltage from A+ to B- corresponds to bit value "1". In X4 connector the RS485 extension port is not galvanically isolated.

11.4 Optional two channel arc protection card

NOTE: When this option card is installed, the parameter "Arc card type" has value "2Arc+BI/O". Please check the ordering code in Chapter 14 Order information.

If the slot X6 is already occupied with the DI19 / DI20 digital input card, this option is not available, but there is still one arc sensor channel available. See Chapter 11.5 Optional digital I/O card (DI19/DI20).

The optional arc protection card includes two arc sensor channels. The arc sensors are connected to terminals X6: 4 – 5 and 6 – 7.

The arc information can be transmitted and/or received through digital input and output channels. This is a 48 V dc signal.

Connections:

X6: 1	Binary input (BI)
X6: 2	Binary output (BO)
X6: 3	Common for BI and BO.
X6: 4-5	Sensor 1
X6: 6-7	Sensor 2

The binary output of the arc option card may be activated by the arc sensors or by any available signal in the output matrix. The binary output can be connected to an arc binary input of another VAMP protection device.

11.5 Optional digital I/O card (DI19/DI20)

NOTE: When this option card is installed, the parameter "Arc card type" has value "Arc+2DI". With DI19/DI20 option only one arc sensor channel is available. Please check the ordering code in Chapter 14 Order information.

If the slot X6 is already occupied with the two channel arc sensor card (Chapter 11.4 Optional two channel arc protection card), this option is not available.

The DI19/DI20 option enables two more digital inputs. These inputs are useful in applications where the contact signals are not potential free. For example trip circuit supervision is such application. The inputs are connected to terminals X6:1 – X6:2 and X6:3 – X6:4.

Connections:

X6:1	DI19+
X6:2	DI19-
X6:3	DI20+
X6:4	DI20-
X6:5	NC
X6:6	L+
X6:7	L-

11.6 External option modules

11.6.1 External LED module VAM 16D

The optional external VAM 16D led module provides 16 extra led-indicators in external casing. Module is connected to the serial port of the device's front panel. Please refer the User manual VAM 16D for details.

11.6.2 Third-party external input / output modules

The device supports optional external input/output modules used to extend the number of digital inputs and outputs. Also modules for analogue inputs and outputs are available.

The following types of devices are supported:

- Analog input modules (RTD)
- Analog output modules (mA-output)
- Binary input/output modules

EXTENSION port is primarily designed for I/O modules. This port is found in the LOCAL connector of the device backplane and I/O devices should be connected to the port with VSE003 adapter.

NOTE: If External I/O protocol is not selected to any communication port, VAMPSET doesn't display the menus required for configuring the I/O devices. After changing EXTENSION port protocol to External I/O, restart the relay and read all settings with VAMPSET.

External analog inputs configuration (VAMPSET only)

EXTERNAL ANALOG INPUTS											
AI Enabled	AI Meas	AI Unit	AI Slave Address	AI ModBus Address	AI Register Type	AI Offset	x1	y1	x2	y2	AI Error Counter
On	0.00 C	C	1	1	HoldingR	0	0	0	1	1	0
Off	0.00 C	C	1	2	HoldingR	0	0	0	1	1	0
Off	0.00 C	C	1	3	HoldingR	0	0	0	1	1	0
On / Off		Enabling for measurement									
C, F, K, mA, Ohm or V/A		Unit selection									
Active value											
1 – 247		Modbus address of the I/O device									
1 – 9999		Modbus register for the measurement									
InputR or HoldingR		Modbus register type									
-32000 – 32000		Offset		Subtracted from Modbus value, before running XY scaling							
X: -32000 – 32000		Y1		Scaled value		Point 1					
Y: -1000 – 1000		X1		Modbus value							
		Y2		Scaled value		Point 2					
		X2		Modbus value							
Communication read errors											

Alarms for external analog inputs

EXTERNAL ANALOG INPUT ALARMS			
AI Enabled	AI Slave Address	AI ModBus Address	AI Meas
On	1	1	0.00 C
Off	1	2	0.00 C
Off	1	3	0.00 C

Range	Description
0 – 10000	Hysteresis for alarm limits
-21x107 – +21x107	Alarm >> Limit setting
- / Alarm	Active state
-21x107 – +21x107	Alarm > Limit setting
- / Alarm	Active state
	Active value
1 – 9999	Modbus register for the measurement
1 – 247	Modbus address of the I/O device
On / Off	Enabling for measurement

Analog input alarms have also matrix signals, “Ext. Aix Alarm1” and “Ext. Aix Alarm2”.

External digital inputs configuration (VAMPSET only)

EXTERNAL DIGITAL INPUTS							Range	Description
DI Enabled	DI State	DI Slave Address	DI ModBus Address	DI Register Type	DI Selected Bit	DI Error Counter		
On	0	1	1	Coils	1	0		Communication read errors
Off	0	1	2	Coils	1	0	1 – 16	Bit number of Modbus register value
Off	0	1	3	Coils	1	0	Coils, InputS, InputR or HoldingR	Modbus register type
							1 – 9999	Modbus register for the measurement
							1 – 247	Modbus address of the I/O device
							0 / 1	Active state
							On / Off	Enabling for measurement

External digital outputs configuration (VAMPSET only)

EXTERNAL DIGITAL OUTPUTS							Range	Description
DO Enabled	DO State	DO Slave Address	DO ModBus Address	DO Error Counter				
On	0	1	1	0			Communication errors	
Off	0	1	2	0		1 – 9999	Modbus register for the measurement	
Off	0	1	3	0		1 – 247	Modbus address of the I/O device	
						0 / 1	Output state	
							Enabling for measurement	

External analog outputs configuration (VAMPSET only)

EXTERNAL ANALOG OUTPUTS												
AO Enabled	mA Output	mA Min	mA Max	AO Link	Linked Val. Min	Linked Val. Max	AO Slave Address	AO Modbus Address	AO Register Type	Modbus Min	Modbus Max	AO Error Counter
On	0.00	0	20	IL1	0 A	1000 A	1	1	HoldingR	0	100	0
Off	0.00	0	20	IL2	0 A	1000 A	1	2	HoldingR	0	100	0
Off	0.00	0	20	IL3	0 A	1000 A	1	3	HoldingR	0	100	0

Range	Description
	Communication errors
-32768 – +32767 (0 – 65535)	Modbus value corresponding Linked Val. Max Modbus value corresponding Linked Val. Min
InputR or HoldingR	Modbus register type
1 – 9999	Modbus register for the output
1 – 247	Modbus address of the I/O device
0 – 42x108, -21x108 – +21x108	Maximum limit for lined value, corresponding to “Modbus Max” Minimum limit for lined value, corresponding to “Modbus Min”
	Link selection
-21x107 – +21x107	Minimum & maximum output values
	Active value
On / Off	Enabling for measurement

11.7 Block optional diagram

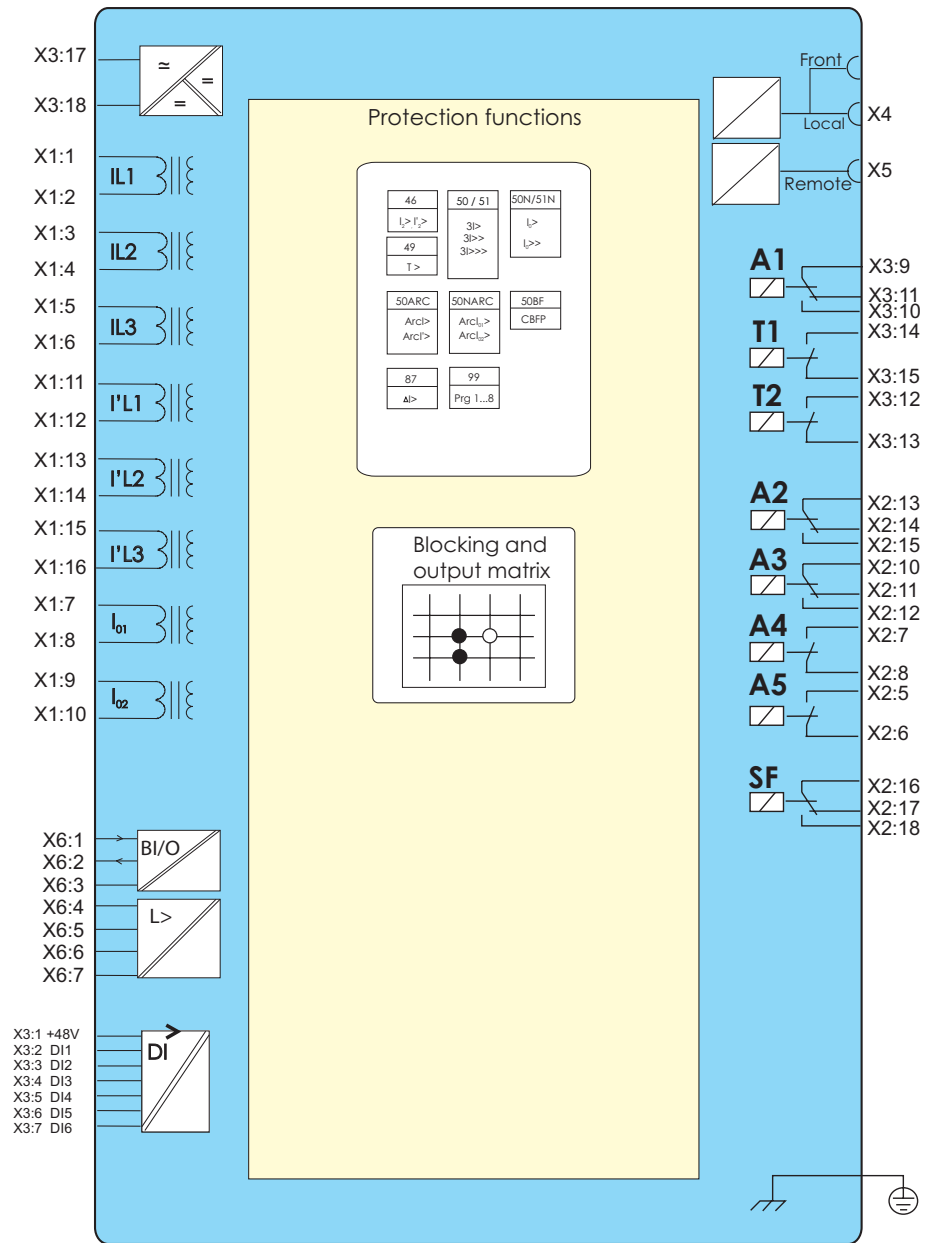

Figure 11.8: Block diagram of VAMP 265

11.8 Block diagrams of option modules

11.8.1 Block diagrams of optional modules

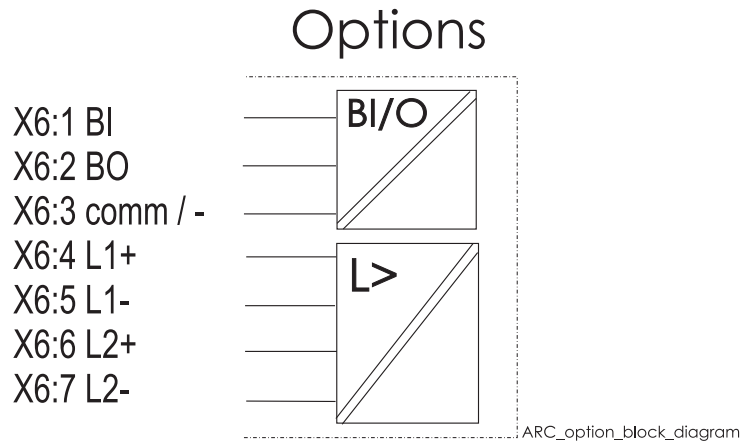

Figure 11.9: Block diagram of optional arc protection module.

11.8.2 Block diagram of optional DI19/DI20

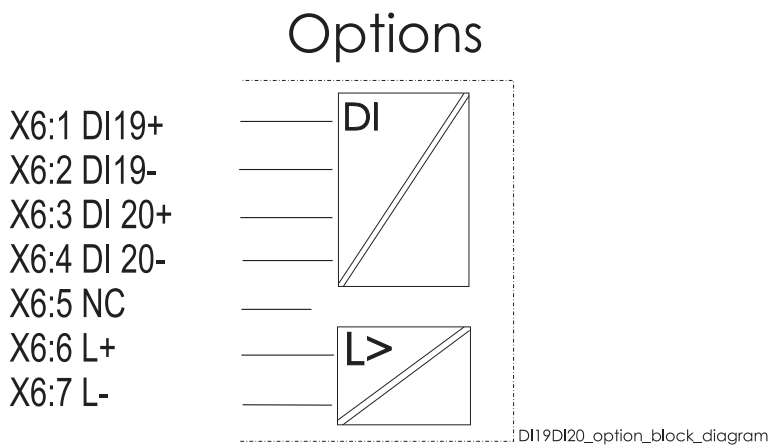
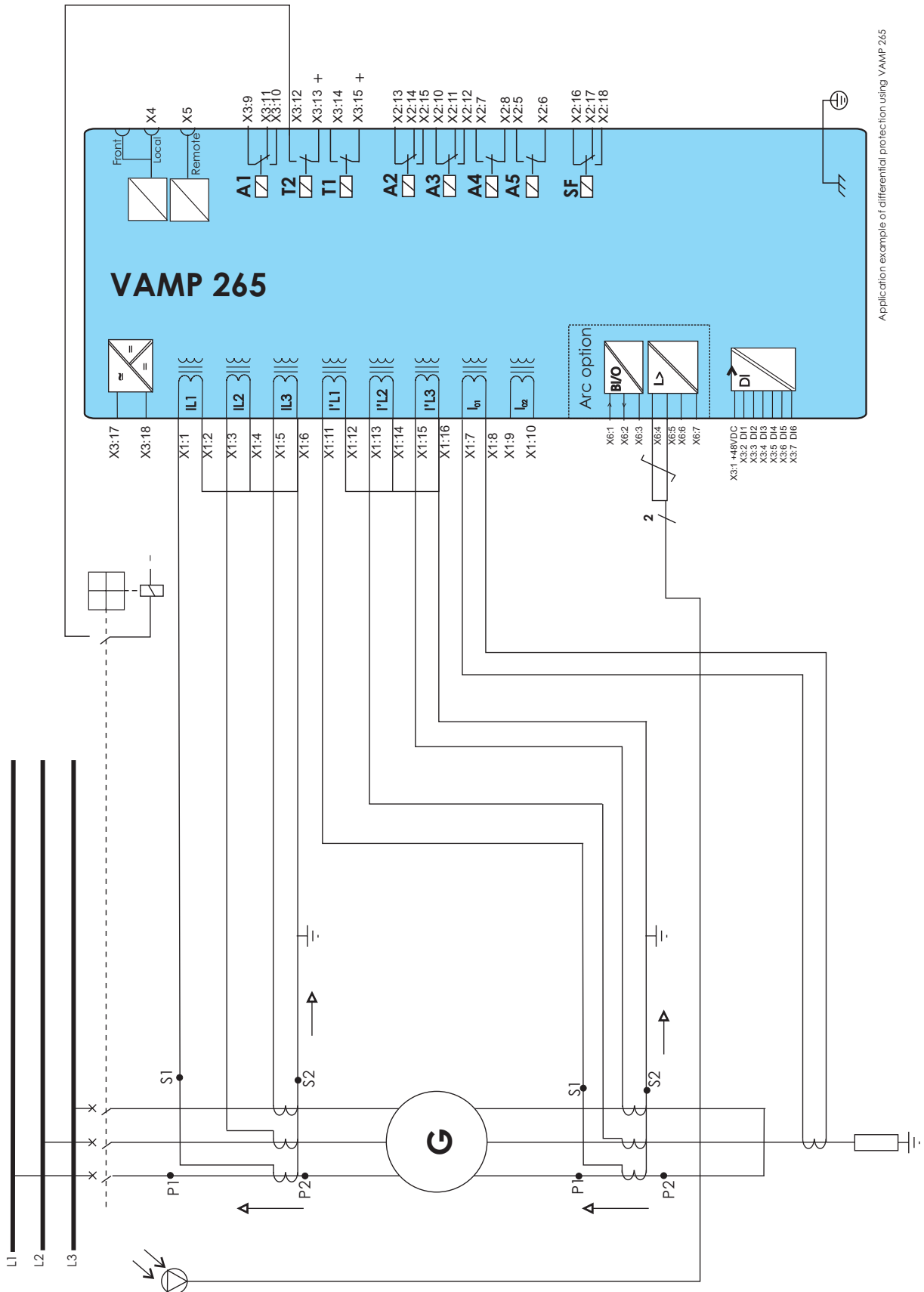

Figure 11.10: Block diagram of optional DI19/DI20 module with one arc channel.

11.9 Connection examples



Application example of differential protection using VAMP 265

Figure 11.11: Connection example of VAMP 265

12 Technical data

12.1 Connections

Table 12.1: Measuring circuits

Rated phase current	5 A (configurable for CT secondaries 1 – 10 A)
- Current measuring range	0 – 250 A
- Thermal withstand	20 A (continuously) / 100 A (for 10 s) / 500 A (for 1 s)
- Burden	0.125 VA
- Impedance	0.005 Ohm
Rated phase current	1 A (configurable for CT secondaries 1 – 10 A)
- Current measuring range	0 – 50 A
- Thermal withstand	4 A (continuously) / 20 A (for 10 s) / 100 A (for 1 s)
- Burden	0.04 VA
- Impedance	0.04 Ohm
Rated residual current (optional)	5 A (configurable for CT secondaries 1 – 10 A)
- Current measuring range	0 – 25 A
- Thermal withstand	20 A (continuously) / 100 A (for 10 s) / 500 A (for 1 s)
- Burden	0.125 VA
- Impedance	0.005 Ohm
Rated residual current	1 A (configurable for CT secondaries 0.1 – 10.0 A)
- Current measuring range	0 – 5 A
- Thermal withstand	4 A (continuously) / 20 A (for 10 s) / 100 A (for 1 s)
- Burden	0.04 VA
- Impedance	0.04 Ohm
Rated frequency f_N	45 – 65 Hz
Terminal block:	Maximum wire dimension:
- Solid or stranded wire	4 mm ² (10 – 12 AWG)

Table 12.2: Auxiliary voltage

	Type A (standard)	Type B (option)
Rated voltage U_{AUX}	40 – 265 V ac/dc	18 – 36 V dc Note! Polarity X3:17= negative (-) X3:18= positive (+)
Start-up peak (DC)		
110 V (Type A)	15 A with time constant of 1ms	
220 V (Type A)	25 A with time constant of 1ms	
Power consumption	< 15 W (normal conditions) < 25 W (output relays activated)	
Max. permitted interruption time	< 50 ms (110 V dc)	
Terminal block: - Phoenix MVSTBW or equivalent	Maximum wire dimension: 2.5 mm ² (13 – 14 AWG)	

Table 12.3: Digital inputs internal operating voltage

Number of inputs	6
Operation time	0.00 – 60.00 s (step 0.01 s)
Polarity	NO (normal open) or NC (normal closed)
Inaccuracy:	
- Operate time	±1% or ±10 ms
Internal operating voltage	48 V dc
Current drain when active (max.)	approx. 20 mA
Current drain, average value	< 1 mA
Terminal block: - Phoenix MVSTBW or equivalent	Maximum wire dimension: 2.5 mm ² (13 – 14 AWG)

Table 12.4: Trip contact

Number of contacts	2 making contacts
Rated voltage	250 V ac/dc
Continuous carry	5 A
Make and carry, 0.5 s	30 A
Make and carry, 3s	15 A
Breaking capacity, AC	2 000 VA
Breaking capacity, DC (L/R=40ms)	
at 48 V dc:	5 A
at 110 V dc:	3 A
at 220 V dc:	1 A
Contact material	AgNi 90/10
Terminal block: - MSTB2.5 - 5.08	Wire dimension: Maximum 2.5 mm ² (13 – 14 AWG) Minimum 1.5 mm ² (15 – 16 AWG)

Table 12.5: Signal contacts

Number of contacts:	3 change-over contacts (relays A1, A2 and A3) 2 making contacts (relays A4 and A5) 1 change-over contact (SF relay)
Rated voltage	250 V ac/dc
Max. make current, 4s at duty cycle 10%	15 A
Continuous carry	5 A
Breaking capacity, AC	2 000 VA
Breaking capacity, DC (L/R=40ms)	
at 48 V dc:	1.3 A
at 110 V dc:	0.4 A
at 220 V dc:	0.2 A
Contact material	AgNi 0.15 gold plated
Terminal block - MSTB2.5 - 5.08	Wire dimension Maximum 2.5 mm ² (13 – 14 AWG) Minimum 1.5 mm ² (15 – 16 AWG)

Table 12.6: Ethernet connection

Number of ports	1
Electrical connection	Ethernet RJ-45 (Ethernet 10-Base-T)
Protocols	VAMPSET Modbus TCP IEC 61850
Data transfer rate	10 Mb/s

Table 12.7: Ethernet fiber interface

Type	Multimode
Connector	LC
Physical layer	100 Base-Fx
Maximum cable distance	2 km
Optical wavelength	1300 nm
Cable core / cladding size	50/125 or 62.5/125 μm

Table 12.8: Local serial communication port

Number of ports	1 on front and 1 on rear panel
Electrical connection	RS 232
Data transfer rate	1 200 – 38 400 kb/s

Table 12.9: Remote control connection (option)

Number of ports	1 on rear panel
Electrical connection	TTL (standard) RS 485 (option) RS 232 (option) Plastic fibre connection (option) Glass fibre connection (option) Ethernet 10 Base-T (option, external module) 100M Ethernet fiber 100M Ethernet copper (RJ 45)
Data transfer rate	1 200 – 19 200 kb/s
Protocols	Modbus, RTU master Modbus, RTU slave SPA-bus, slave IEC 60870-5-103 Profibus DP (option) Modbus TCP (internal / external optional module) IEC 60870-5-101 IEC 60870-5-101 TCP DNP 3.0 DNP 3.0 TCP IEC 61850

Table 12.10: Arc protection interface (option)

Number of arc sensor inputs	2
Sensor type to be connected	VA 1 DA
Operating voltage level	12 V dc
Current drain, when active	> 11.9 mA
Current drain range	1.3 – 31 mA (Note! If the drain is outside the range, either sensor or the wiring is defected)
Number of binary inputs	1 (optically isolated)
Operating voltage level	+48 V dc
Number of binary outputs	1 (transistor controlled)
Operating voltage level	+48 V dc

NOTE: Maximally three arc binary inputs can be connected to one arc binary output without an external amplifier.

12.2 Test and environmental conditions

Table 12.11: Disturbance tests

Test	Standard & Test class / level	Test value
Emission	EN 61000-6-4 / IEC 60255-26	
- Conducted	EN 55011, Class A / IEC 60255-25	0.15 – 30 MHz
- Emitted	EN 55011, Class A / IEC 60255-25 / CISPR 11	30 – 1000 MHz
Immunity	EN 61000-6-2 / IEC 60255-26	
- 1Mhz damped oscillatory wave	IEC 60255-22-1	±2.5kVp CM, ±1.0kVp DM
- Emitted HF field	EN 61000-4-3 Level 3 / IEC 60255-22-3	80 - 1000 MHz, 10 V/m
- Fast transients (EFT)	EN 61000-4-4 Level 3 / IEC 60255-22-4 Class B	2 kV, 5/50 ns, 5 kHz
- Surge	EN 61000-4-5 Level 3 / IEC 60255-22-5	2 kV, 1.2/50 µs, CM 1 kV, 1.2/50 µs, DM
- Conducted HF field	EN 61000-4-6 Level 3 / IEC 60255-22-6	0.15 - 80 MHz, 10 Vemf
- Power-frequency magnetic field	EN 61000-4-8	300A/m (continuous)
- Pulse magnetic field	EN 61000-4-9 Level 5	1000A/m, 1.2/50 µs
- Voltage interruptions	IEC 60255-11	10ms / 100%
- Voltage dips and short interruptions	EN 61000-4-11	30%/10ms, 100%/10ms, 60%/100ms, >95%/5000ms
- Voltage alternative component	IEC 60255-11	12% of operating voltage (DC)

Table 12.12: Electrical safety tests

Test	Standard & Test class / level	Test value
- Impulse voltage withstand	EN 60255-5, Class III	5 kV, 1.2/50 ms, 0.5 J 1 kV, 1.2/50 ms, 0.5 J Communication
- Dielectric test	EN 60255-5, Class III	2 kV, 50 Hz 0.5 kV, 50 Hz Communication
- Insulation resistance	EN 60255-5	
- Protective bonding resistance	EN 60255-27	
- Power supply burden	IEC 60255-1	

Table 12.13: Mechanical tests

Vibration (IEC 60255-21-1) Class I	10 – 60 Hz, amplitude ±0.035 mm 60 – 150 Hz, acceleration 0.5g sweep rate 1 octave/min 20 periods in X-, Y- and Z axis direction
Shock (IEC 60255-21-1) Class I	half sine, acceleration 5 g, duration 11 ms 3 shocks in X-, Y- and Z axis direction

Table 12.14: Environmental conditions

Ambient temperature, in-service	-40 – 60°C (-40 – 140°F)
Ambient temperature, storage	-40 – 70°C (-40 – 158°F)
Relative air humidity	< 95%
Maximum operating altitude	2000 m (6561.68 ft)

Table 12.15: Casing

Degree of protection (IEC 60529)	Standard: IP30 front panel. IP20 rear panel Option: IP54 front panel, IP 20 rear panel
Dimensions (w x h x d):	208 x 155 x 225 mm / 8.19 x 6.10 x 8.86 in
Material	1 mm (0.039 in) steel plate
Weight	4.2 kg (9.272 lb)
Colour code	RAL 7032 (Casing) / RAL 7035 (Back plate)

Table 12.16: Package

Dimensions (W x H x D)	215 x 160 x 275 mm / 8.46 x 6.30 x 10.83 in
Weight (Terminal, Package and Manual)	5.2 kg (11.479 lb)

12.3 Protection functions

*) EI = Extremely Inverse, NI = Normal Inverse, VI = Very Inverse, LTI = Long Time Inverse, MI = Moderately Inverse

***) This is the instantaneous time i.e. the minimum total operational time including the fault detection time and operation time of the trip contacts.

12.3.1 Differential protection

Table 12.17: Differential overcurrent stage $\Delta I >$ (87)

Pick up value	5 – 50 % I_N
Bias current for start of slope 1	0.50 x I_N
Slope 1	5 – 100 %
Bias current for start of slope 2	1.00 – 3.00 x I_N
Slope 2	100 – 200 %
Second harmonic blocking	5 – 30 %, or disable
Fifth harmonic blocking	20 – 50 %, or disable
Reset time	< 95 ms
Reset ratio:	0.95
Inaccuracy:	
- 2nd harmonic blocking	±2% - unit
- 5th harmonic blocking	±3% - unit
- Starting	±3% of set value or 0.02 x I_N when currents are < 200 mA
- Operating time ($I_D > 1.2 \times I_{SET}$)	< 60 ms
- Operating time ($I_D > 3.5 \times I_{SET}$)	< 50 ms

NOTE: The amplitude of second harmonic content has to be at least 2% of the nominal of CT. If the nominal current is 5 A, the 100 Hz component needs to exceed 100 mA.

Table 12.18: Differential overcurrent stage $\Delta I >>$ (87)

Pick-up value	5.0 – 40.0 x I_N
Reset time	< 95 ms
Reset ratio:	0.95
Inaccuracy:	
- Starting	±3% of set value or ±0.5% of rated value
- Operating time ($I_D > 3.5 \times I_{SET}$)	< 40 ms

12.3.2 Non-directional current protection

Table 12.19: Overcurrent stage I>, I'> (50/51)

Pick-up value	0.10 – 5.00 x I _N (step 0.01)
Definite time function:	DT**
- Operating time	0.08** – 300.00 s (step 0.01 s)
IDMT function:	
- Delay curve family	(DT), IEC, IEEE, RI Prg
- Curve type	EI, VI, NI, LTI, MI..., depends on the family*
- Time multiplier k	0.05 – 20.0, except 0.50 – 20.0 for RXIDG, IEEE and IEEE2
Start time	Typically 30 ms
Reset time	<95 ms
Retardation time	< 50 ms
Reset ratio:	0.97
Transient over-reach, any τ	< 10 %
Inaccuracy:	
- Starting	±3% of the set value or 5 mA secondary
- Operating time at definite time function	±1% or ±25 ms
- Operating time at IDMT function	±5% or at least ±25 ms**

Table 12.20: Overcurrent stages I>>, I'>> (50/51)

Pick-up value	0.10 – 20.00 x I _N (step 0.01)
Definite time function:	DT**
Operating time	0.04 – 1800.00 s (step 0.01 s)
Start time	Typically 30 ms
Reset time	<95 ms
Retardation time	< 50 ms
Reset ratio:	0.97
Transient over-reach, any τ	< 10 %
Inaccuracy:	
- Starting	±3% of the set value or 5 mA secondary
- Operation time	±1% or ±25 ms

Table 12.21: Thermal overload stage $T >$ (49)

Maximum continuous current:	0.1 – 2.40 x I_N (step 0.01)
Alarm setting range:	60 – 99 % (step 1%)
Time constant Tau:	2 – 180 min (step 1)
Cooling time coefficient:	1.0 – 10.0 x Tau (step 0.1)
Max. overload at +40°C	70 – 120 % I_N (step 1)
Max. overload at +70°C	50 – 100 % I_N (step 1)
Ambient temperature	-55 – 125°C (step 1°)
Resetting ratio (Start & trip)	0.95
Accuracy:	
- Operating time	±5% or ±1 s

Table 12.22: Unbalance stage $I_2 >$, $I'_2 >$ (46)

Pick-up value	2 – 70% (step 1%)
Definite time characteristic:	
- Operating time	1.0 – 600.0 s (step 0.1 s)
Inverse time characteristic:	
- 1 characteristic curve	Inv
- time multiplier	1 – 50 s (step 1)
- upper limit for inverse time	1000 s
Start time	Typically 300 ms
Reset time	< 450 ms
Reset ratio:	0.95
Inaccuracy:	
- Starting	±1% - unit
- Operate time	±5% or ±200 ms

NOTE: Stage is operational when all secondary currents are above 250 mA.

Table 12.23: Earth fault stage $I_0 >$ (50N/51N)

Input signal	I_{01} (input X1:7 – 8) I_{02} (input X1:9 – 10) I_{0Calc} (= $I_{L1} + I_{L2} + I_{L3}$)
Pick-up value	0.005 – 8.00 pu (when I_{01} or I_{02}) (step 0.001) 0.05 – 20.0 pu (when I_{0Calc})
Definite time function: - Operating time	DT** 0.04** – 300.00 s (step 0.01 s)
IDMT function:	
- Delay curve family	(DT), IEC, IEEE, RI Prg
- Curve type	EI, VI, NI, LTI, MI..., depends on the family*
- Time multiplier k	0.05 – 20.0, except 0.50 – 20.0 for RXIDG, IEEE and IEEE2
Start time	Typically 30 ms
Reset time	<95 ms
Reset ratio:	0.95
Inaccuracy:	
- Starting	±2% of the set value or ±0.3% of the rated value
- Starting (Peak mode)	±5% of the set value or ±2% of the rated value (Sine wave <65 Hz)
- Operating time at definite time function	±1% or ±25 ms
- Operating time at IDMT function	±5% or at least ±25 ms**

Table 12.24: Earth fault stages $I_0 >>$, $I_0 >>>$, $I_0 >>>>$ (50N/51N)

Input signal	I_{01} (input X1:7 – 8) I_{02} (input X1:9 – 10) I_{0Calc} (= $I_{L1} + I_{L2} + I_{L3}$)
Pick-up value	0.01 – 8.00 pu (When I_{01} or I_{02}) (step 0.01) 0.05 – 20.0 pu (When I_{0Calc}) (step 0.01)
Definite time function: - Operating time	0.04** – 300.00 s (step 0.01 s)
Start time	Typically 30 ms
Reset time	<95 ms
Reset ratio:	0.95
Inaccuracy:	
- Starting	±2% of the set value or ±0.3% of the rated value
- Starting (Peak mode)	±5% of the set value or ±2% of the rated value (Sine wave <65 Hz)
- Operate time	±1% or ±25 ms

12.3.3 Circuit-breaker failure protection CBFP (50BF)

Table 12.25: Circuit-breaker failure protection CBFP (50BF)

Relay to be supervised	T1 – T12
Definite time function:	
- Operating time	0.1** – 10.0 s (step 0.1 s)
Inaccuracy	
- Operating time	±20 ms

12.3.4 Magnetising inrush 68F2

Table 12.26: Magnetising inrush 68F2

Settings:	
- Pick-up value	10 – 100 % (step 1%)
- Operating time	0.03 – 300.00 s (step 0.01 s)
Inaccuracy:	
- Starting	±1% - unit

NOTE: The amplitude of second harmonic content has to be at least 2% of the nominal of CT. If the nominal current is 5 A, the 100 Hz component needs to exceed 100 mA.

12.3.5 Over excitation 68F5

Table 12.27: Over excitation 68F5

Settings:	
- Setting range over excitation	10 – 100 % (step 1%)
- Operating time	0.03 – 300.00 s (step 0.01 s)
Inaccuracy:	
- Starting	±2%- unit

NOTE: The amplitude of fifth harmonic content has to be at least 2% of the nominal of CT. If the nominal current is 5 A, the 250 Hz component needs to exceed 100 mA.

12.3.6 Arc fault protection (option)

The operation of the arc protection depends on the setting value of the $Arcl_{>}$, $Arcl_{01}>$ and $Arcl_{02}>$ current limits.

The arc current limits cannot be set, unless the relay is provided with the optional arc protection card.

Table 12.28: Arc protection stage $Arcl_{>}$ (50ARC), $Arcl_{01}>$ (50NARC), $Arcl_{02}>$ (50NARC)

Pick-up value	$0.5 - 10.0 \times I_N$
Arc sensor connection:	S1, S2, S1/S2, BI, S1/BI, S2/BI, S1/S2/BI
- Operating time (Light only)	13 ms
- Operating time ($4 \times I_{SET} + \text{light}$)	17ms
- Operating time (BIN)	10 ms
- Operating time (Delayed Arc L>)	0.01 – 0.15 s
- BO operating time	< 3 ms
Reset time	<95 ms
Reset time (Delayed ARC L)	<120 ms
Reset time (BO)	< 85 ms
Reset ratio:	0.90
Inaccuracy:	
- Starting	10% of the set value
- Operating time	± 5 ms
- Delayed ARC light	± 10 ms

12.4 Supporting functions

The operation of disturbance recorder depends on the following settings. The recording time and the number of records depend on the time setting and the number of selected channels.

Table 12.29: Disturbance recorder (DR)

Mode of recording	Saturated / Overflow
Sample rate:	
- Waveform recording	32/cycle, 16/cycle, 8/cycle
- Trend curve recording	10, 20, 200 ms 1, 5, 10, 15, 30 s 1 min
Recording time (one record)	0.1 s – 12 000 min (According recorder setting)
Pre-trigger rate	0 – 100%
Number of selected channels	0 – 12

The recording time and the number of records depend on the time setting and the number of selected channels.

Table 12.30: Current transformer supervision

$I_{MAX}>$ setting	0.00 – 10.00 x I_N (step 0.01)
$I_{MIN}<$ setting	0.00 – 10.00 x I_N (step 0.01)
Definite time function:	DT
- Operating time	
Reset time	< 60 ms
Reset ratio $I_{MAX}>$	0.97
Reset ratio $I_{MIN}<$	1.03
Inaccuracy:	
- Activation	±3% of the set value
- Operating time at definite time function	±1% or ±30 ms

13 Mounting

VAMP 200 SERIES PANEL MOUNTING

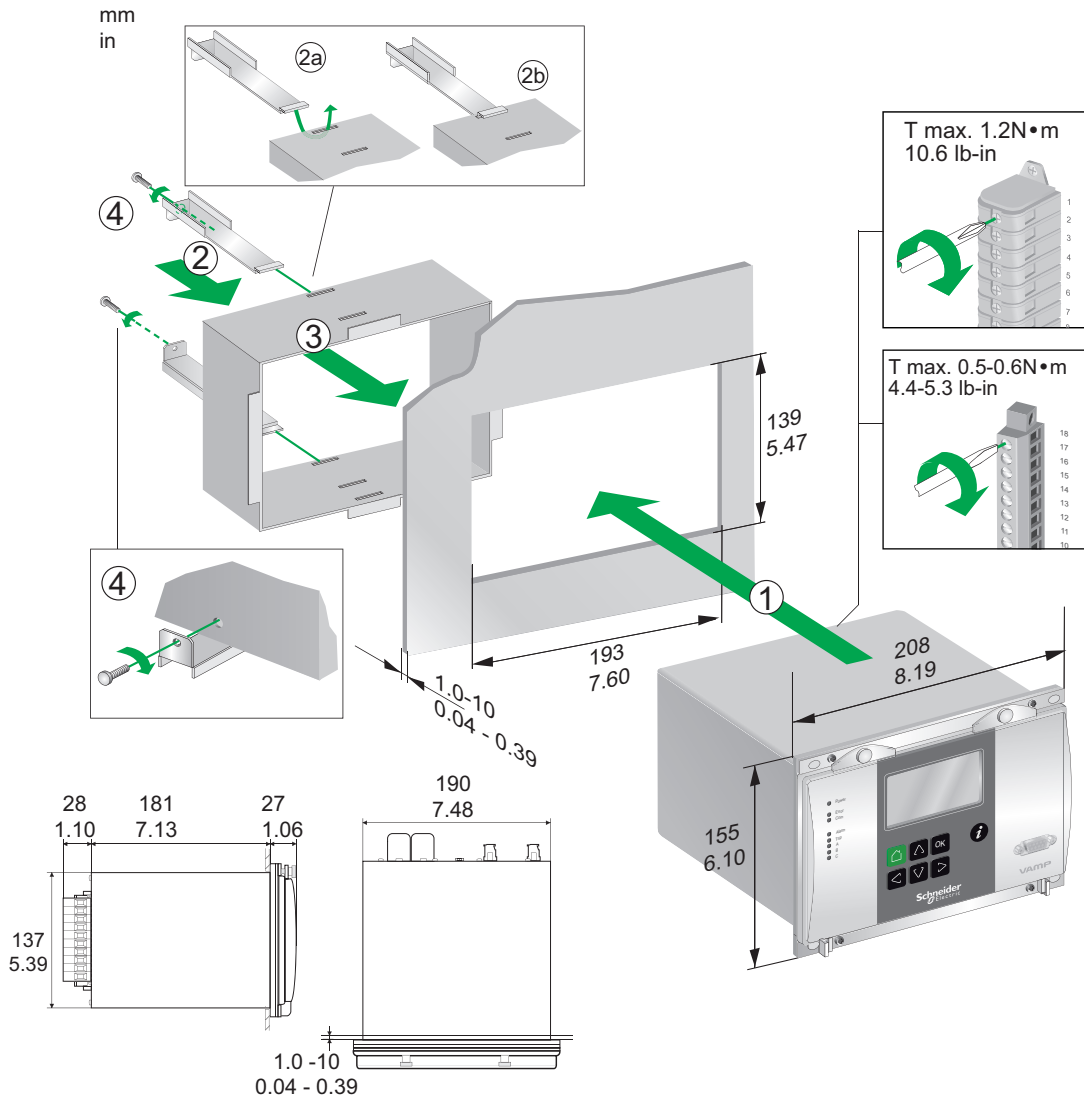

PROJECTION MOUNTING VAMP 200 SERIES

Projection	A	B
VYX076	40 mm / 1.57"	169 mm / 6.65"
VYX077	60 mm / 2.36"	149 mm / 5.87"
VYX233	100 mm / 3.94"	109 mm / 4.29"

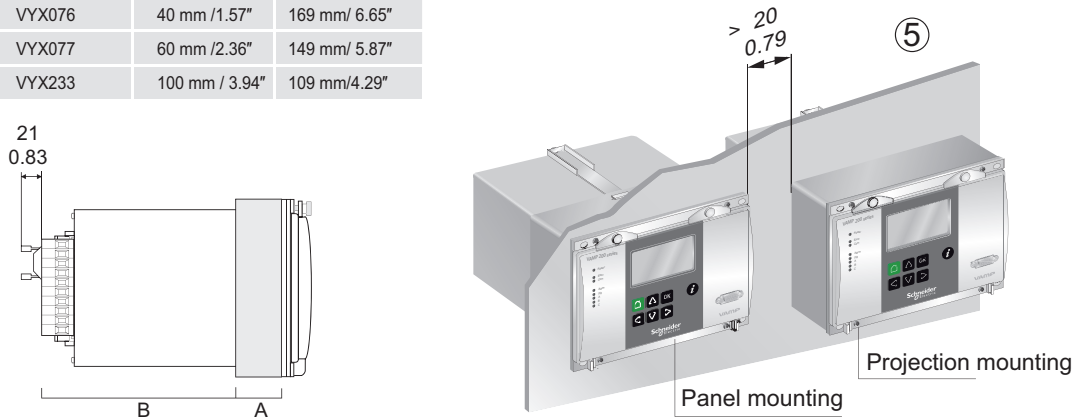

VAMP 200 SERIES WALL ASSEMBLY FRAME TYPE V200WAF

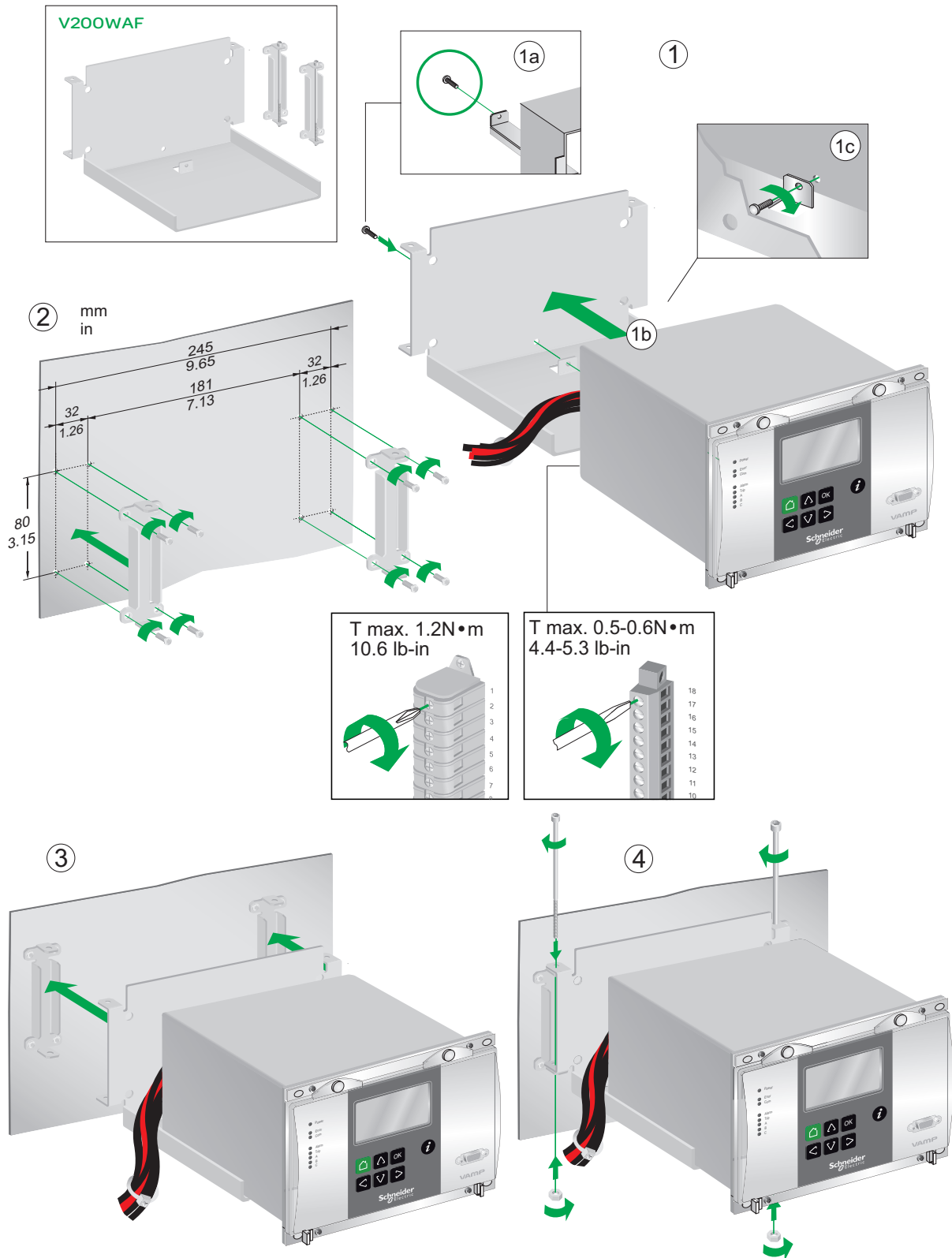

14 Order information

When ordering, please state:

- Type designation:
- Quantity:
- Accessories (see respective ordering code):

V265 - -

Transformer and machine differential

Nominal current, HV & LV side [A]

- 1** = 1A & 1A
- 3** = 1A & 5A
- 4** = 5A & 1A
- 5** = 5A & 5A

Nominal earth-fault currents I_o & $I'o$ [A]

- A** = 5A & 5A
- B** = 5A & 1A
- C** = 1A & 5A
- D** = 1A & 1A

Frequency [Hz]

- 7** = Standard relay

Nominal Supply voltage [V]

- A** = Power A 48 - 230 V (40.. 265Vac/dc)
- B** = Power B 24 V (18.. 36Vdc)
- C** = Power C 48 - 230 V (40.. 265Vac/dc) + 1 x BI/BO, 2 x Arc sensor
- D** = Power D 24 V (18.. 36Vdc) + 1 x BI/BO, 2 x Arc sensor
- E** = Power E 48 - 230 V (40.. 265Vac/dc) + DI19, DI20 + 1 x Arc sensor
- F** = Power F 24 V (18.. 36Vdc) + DI19, DI20 + 1 x Arc sensor

Optional hardware

- A** = None
- B** = Plastic/Plastic serial fibre interface
- C** = Profibus interface
- D** = RS 485 interface (4-wire)
- E** = Glass/Glass serial fibre interface
- F** = Rx Plastic/Tx Glass serial fibre interface
- G** = Rx Glass/Tx Plastic serial fibre interface
- H** = RJ-45 10Mbps ethernet interface
- M** = RJ-45 10Mbps ethernet inc. IEC 61850
- O** = LC 100 Mbps ethernet fibre interface inc. IEC 61850
- P** = RJ-45 100Mbps ethernet interface inc. IEC 61850
- R** = 2 x LC 100 Mbps ethernet fibre interface inc. IEC 61850
- S** = 2 x RJ-45 100 Mbps ethernet interface inc. IEC 61850

Software, mA outputs

- E** = Transformer and machine differential firmware, None
- F** = Transformer and machine differential firmware, 4mA output
- M** = Motor protection and machine differential firmware, None

HW options

- = IP30 (default)
- C** = IP30 with conformal coating
- I** = IP54
- K** = IP54 with conformal coating

Accessories

Order code	Description	Note
VEA 3CGi	Ethernet adapter	
VPA 3CG	Profibus DP fieldbus option board	
VSE001PP	Fibre optic Interface Module (plastic - plastic)	Max. distance 30 m
VSE002	RS485 Interface Module	
VSE003	Local port RS-485 interface module,Ext I/O interface	
VSE009	External DeviceNet interface module	
VIO 12 AB	RTD Module, 12pcs RTD inputs, RS 485 Communication (24-230 Vac/dc)	
VIO 12 AC	RTD/mA Module, 12pcs RTD inputs, PTC, mA inputs/outputs, RS232, RS485 and Optical Tx/Rx Communication (24 Vdc)	
VIO 12 AD	RTD/mA Module, 12pcs RTD inputs, PTC, mA inputs/outputs, RS232, RS485 and Optical Tx/Rx Communication (48-230 Vac/dc)	
VX003-3	RS232 programming cable (VAMPSET, VEA 3CGi)	Cable length 3m
3P025	USB to RS232 adapter	
VX004-M3	TTL/RS232 converter cable (PLC, VEA 3CGi)	Cable length 3m
VX004-M10	TTL/RS232 converter cable (PLC, VEA 3CGi)	Cable length 10m
VX007-F3	TTL/RS232 converter cable (VPA 3CG)	Cable length 3m
VA 1 DA-6	Arc sensor	Cable length 6 m
VAM 16D	External LED module	Disables rear local communication
VYX 076	Projection for 200 series	Height 40mm
VYX 077	Projection for 200 series	Height 60mm
VYX 233	Projection for 200 series	Height 100mm
V200WAF	V200 wall assembly frame	

15 Revision history

10.106	GOOSE supervision signals added
10.108	Various additions to IEC 61850
10.116	<p>IP and other TCP parameters are able to change without reboot</p> <p>Logic output numbering is not changed when changes are made in the logic</p> <p>NOTE! Vampset version 2.2.97 required</p>
10.118	<p>Enable sending of analog data in GOOSE message</p> <p>Day light saving (DST) rules added for system clock</p> <p>HMI changes:</p> <ul style="list-style-type: none"> • Order of the first displays changed, 1.measurement, 2. mimic, 3. title • timeout does not apply if the first 3 displays are active
10.161	<ul style="list-style-type: none"> - IEC 101 over Ethernet added - I>>> protection stage added - I>>> protection stage operation time changed from 40 ms to <30 ms - I>>> Overcurrent Protection Stage - Possibility to compare two signals in programmable stages added - Alarms for ExtAI/RTD: RTD open/RTD shorted/RTD communication loss added - Disturbance recorder memory doubled - Protection stage start & trips signals to Disturbance recorder added - CTS (current transformer supervision) for I_{DIFF}> added - T> Time to trip also available as seconds - Inverse stall delay is now propotional to (Istart/Imeas)^2 instead of the plain ratio (Istart/Imeas) - Analog output: Fast DAC mode scaling and PF corrected - ModbusTCPs allows 2 simultaneous connections - ModbusTCPs and ModbusSlv can be used simultaneously - IF relay -> SF relay (Service status output) - Thermal overload available as AO Link in EXTERNAL ANALOG OUTPUTS added - Default sample rate is now 32/cycle in disturbance recorder - LED status indication - Parameter for setting Inv time coefficient k -Remote rebooting of the relay added - Disturbance Recorder's NVRAM memory size increased to double amount - Day light saving automatic change improvement - Following stages renamed: <ol style="list-style-type: none"> 1. If2> = MAGNETISING INRUSH 68F2 2. If5> = OVER EXCITATION 68F5

15 Revision history

10.175	>: Pick-up limit setting minimum value changed from 0.10 to 0.05 Number of setting groups increased from 2 to 4 When accept zero delay enabled, stages' definite operation delay can be set to 0 Relay name can be 10 characters long
--------	--



Customer Care Centre

<http://www.schneider-electric.com/CCC>

Schneider Electric

35 rue Joseph Monier
92506 Rueil-Malmaison
FRANCE

Phone: +33 (0) 1 41 29 70 00

Fax: +33 (0) 1 41 29 71 00

www.schneider-electric.com/vamp-protection

Publication version: V265/en M/G014

Publishing: Schneider Electric

03/2017